

# Guide A: Environmental Design

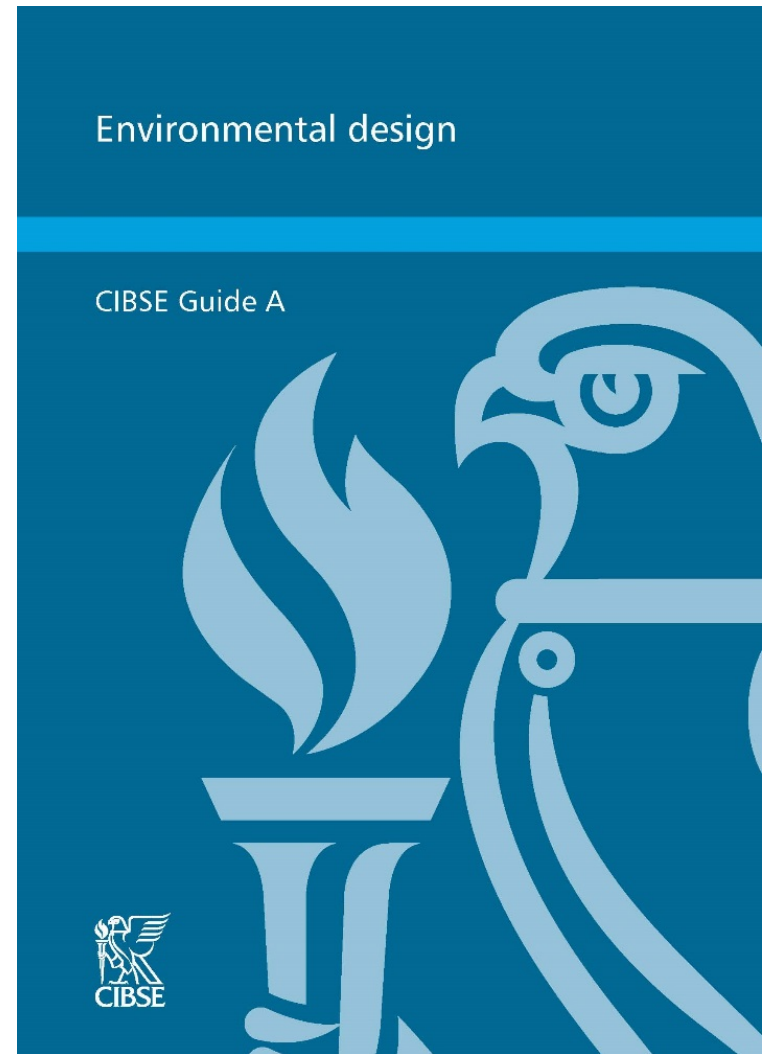

WiFi: Password: MOL15XMOL15X

Follow @CIBSE



# Guide A: Environmental Design

Launch: 22 July 2015

## 18:00 – Session 1

- Derrick Braham, Chair - Welcome
- Chapter 0 - Quality in Environmental Design
- Chapter 1 Environmental Criteria for Design
- Chapter 2 External Design Data

## 18:45 – Session 2

- Chapter 3 Thermal properties of Building Structures
- Chapter 4 Ventilation and Infiltration
- Chapter 5 Thermal Response and Plant Sizing

## 19:25 – Session 3

- Chapter 6 Internal Heat Gains
- Chapter 7 Moisture transfer and Condensation
- Chapter 8 Health Issues
- 20:05 - Concluding Address
- 20:10 – Drinks reception



WIFI: Password: Follow @CIBSE



# Derrick Braham Guide A Steering Group Chair

Welcome to the Launch



# Guide A: Environmental Design

This is the 8<sup>th</sup> edition of CIBSE Guide A: *Environmental Design*.

It is the premier UK technical reference source for designers and installers of heating, ventilating and air conditionings services.

It enables engineers to design comfortable, environmentally sustainable, energy efficient buildings that are a pleasure to live and work and spend leisure time in.

It comprehensively updates its immediate predecessor and contains many significant changes in both format and content.

- Published March 2015 – Most popular CIBSE document
- Downloaded 6,677 times (free to members)
- Hard copies sold 58.

# Guide A: Environmental Design

It presents the professional expertise of UK's foremost designers and researchers in the HEVAC field.

Many represent CIBSE on International, European and National standards committees.

All are volunteers and most have served on the earlier Guides, CIBSE is especially grateful to their employers who have generously given the time off for this work.

# Guide A: Environmental Design

Each Guide A is part of a continuing publication programme and each successive edition relies on material provided for previous editions.

All this earlier material has been comprehensively reviewed , revised and brought up to-date and many chapters have had to be increased in content . Indeed one new chapter had to be created to reflect the changes in quality standards / performance / reliability now expected, since the previous edition.

# Guide A Steering Committee

- Brian Anderson – BRE Scotland
- David Arnold – Troup Bywaters + Anders
- Michael Holmes – Arup
- Michael Humphreys – Oxford Brookes
- Geoff Levermore – University of Manchester
- Martin Liddament – VEETEC Ltd
- Fergus Nicol – Oxford Brookes
- Marialena Nikolopoulou – University of Kent
- Foroutan Parand- AECOM
- Chris Sanders – Glasgow Caledonia University
- David Williams – WSP/Parsons Bickerhoff
- Runming Yao – University of Reading
- Sanaz Agha – CIBSE (secretary)

**Foroutan Parand**  
**AECOM**

## Chapter 0 - Environmental Design





# CIBSE Guide A: Environmental design

CIBSE Guide A:

Environmental design is the premier reference source for designers of low energy sustainable buildings.

It is perceived as a guide to good current practice and CIBSE members are encouraged to follow the guidance in discharging their design duties.

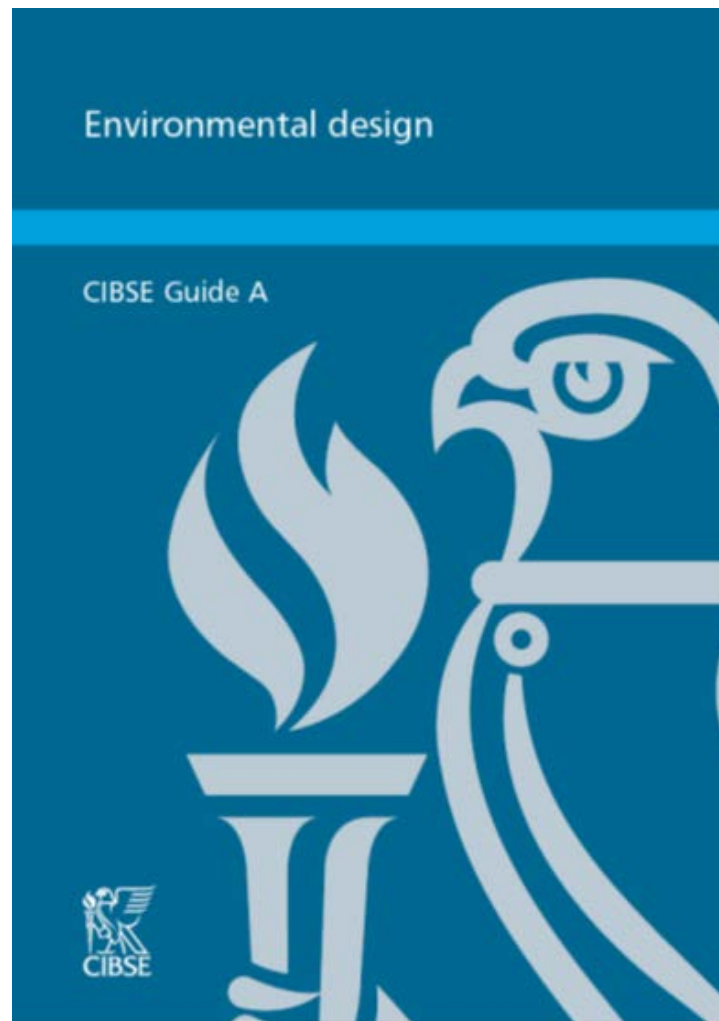

# Chapter 0 - Environmental Design

Purpose of Chapter 0:

- 1- Introduction to the guide.  
emphasise on sustainability
- 2- Emphasise on the need for quality of design

Is the product (building) fit for its purpose?

- Safety, health & comfort
- Low impact on environment

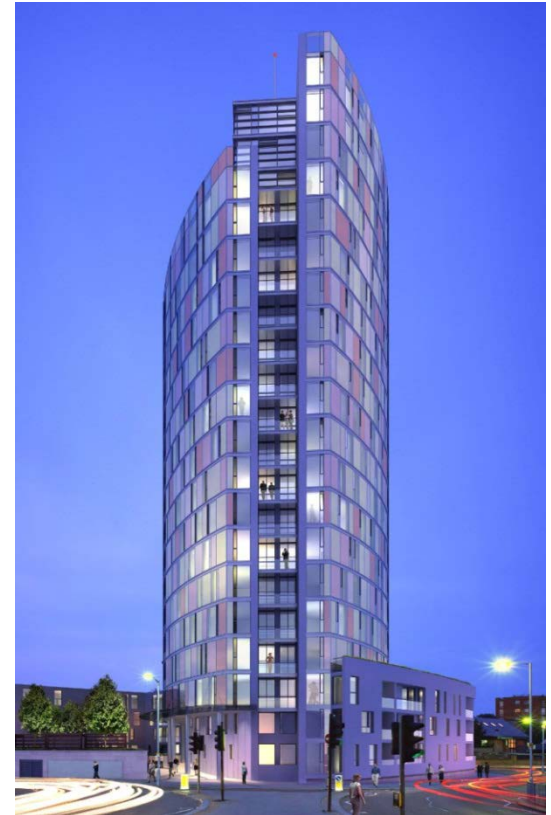

# Achieving quality

- Holistic approach to design
- Early engagement in the design process
- Environmental design process
- Quality Plan
- Quality Procedures

A0's objective: quality sustainable design



# Holistic approach to design

- Understanding the brief
- Understanding the constraints
- Communication with other design team members
- Integrated design

Output: Healthy, safe, comfortable, sustainable

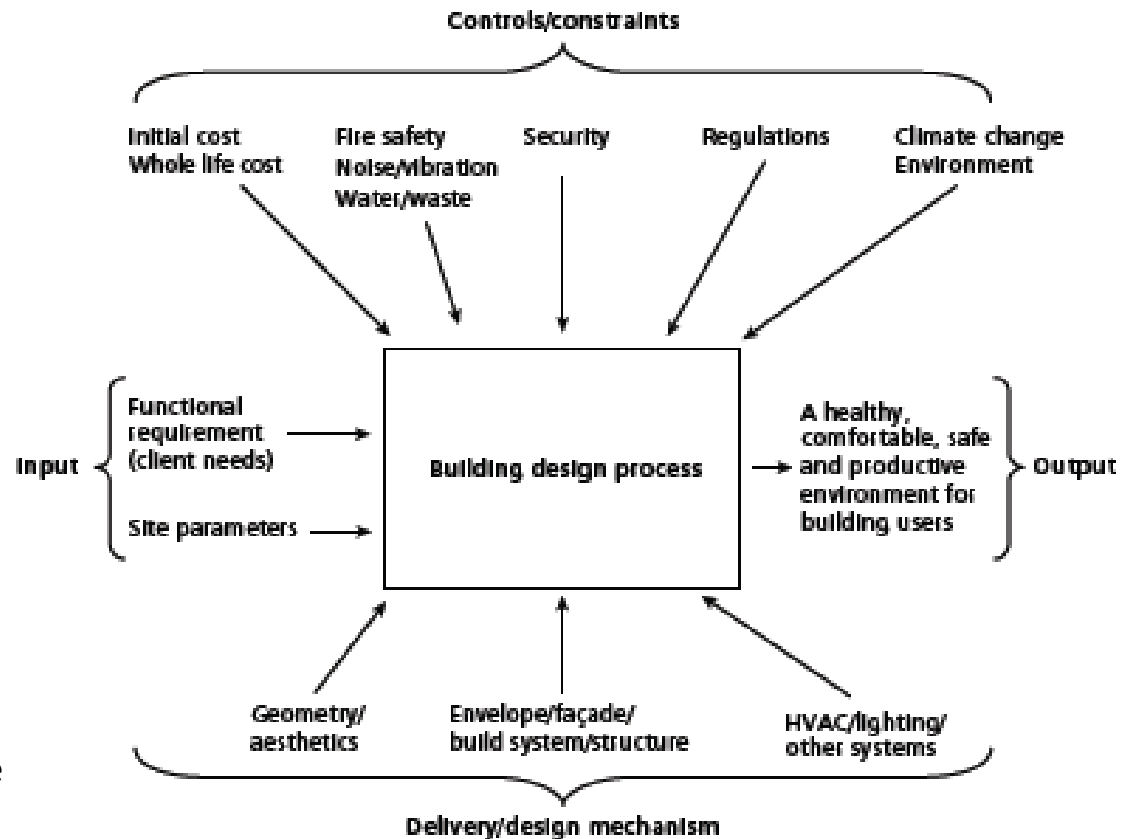
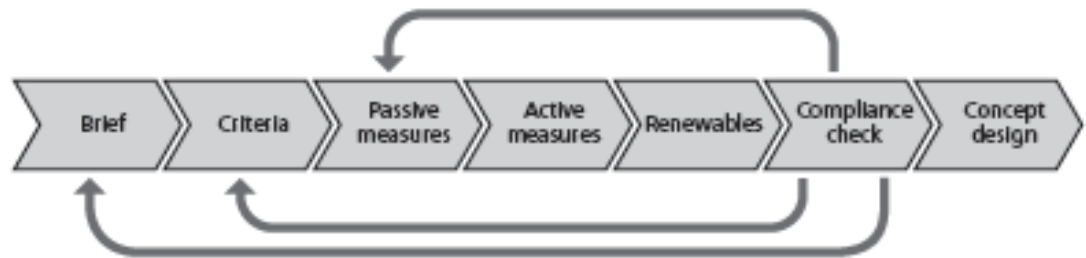

Figure 0.1 of the guide

# Early engagement & options test

- Highlights importance of low energy design options
- Design is a sequential but iterative process
- When information is not available, assumptions must be made with the risk associated to them.

Figure 0.2 of the guide



# Design flow chart and how to use the guide

- A generic design flow chart for building services design:
- Also a guide to different chapters of the Guide A

You may need to adapt the flow chart to your practice and processes

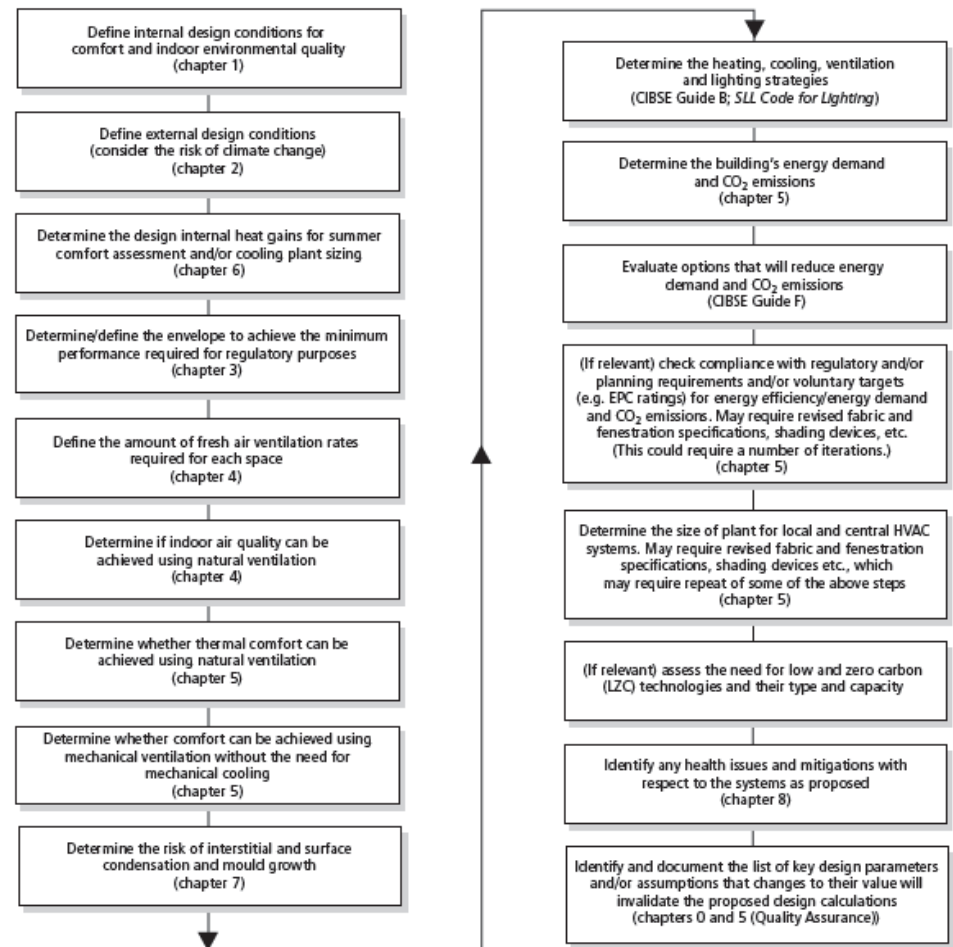
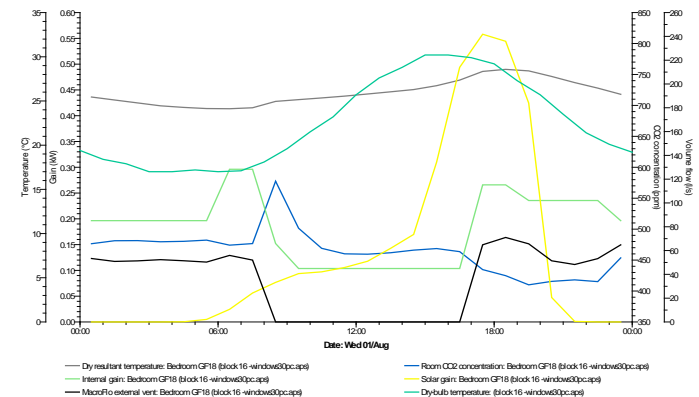
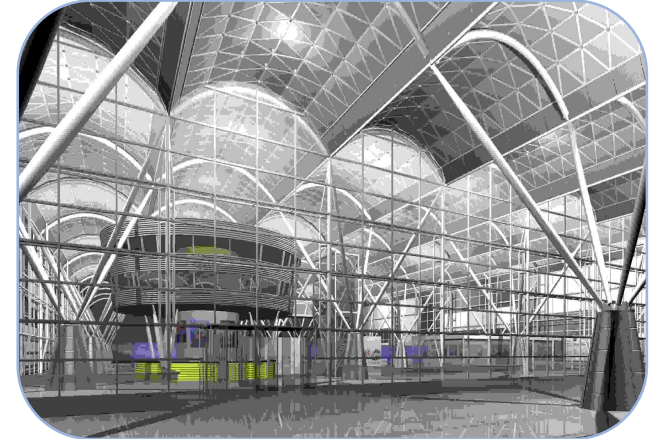

Figure 0.3 Generic design flow chart indicating chapter and publication references where information can be found

# Design is not just compliance with Part L

- Part L has focused minds of clients and designers on energy aspects of the design.
- Health and comfort in some designs may have suffered as a side effect.
- The guide warns that design is not just Part L.
  - Part L uses a single usage scenario.
  - Designers must consider all possible scenarios.
- QA plan should help avoid the potential problem.



# Quality plan

- Quality Policy
  - Management commitment
- Right Resources
  - Knowledge, skill, tools
- Quality Procedures
  - How to do assessments
  - How to check the calculations
  - How to do house keeping
- Adapt to your practice and problems

For more details and how to set up QA refers to CIBSE AM 11

A complete rewrite of AM11 will be published soon

Figure 0.5 – Quality flow chart

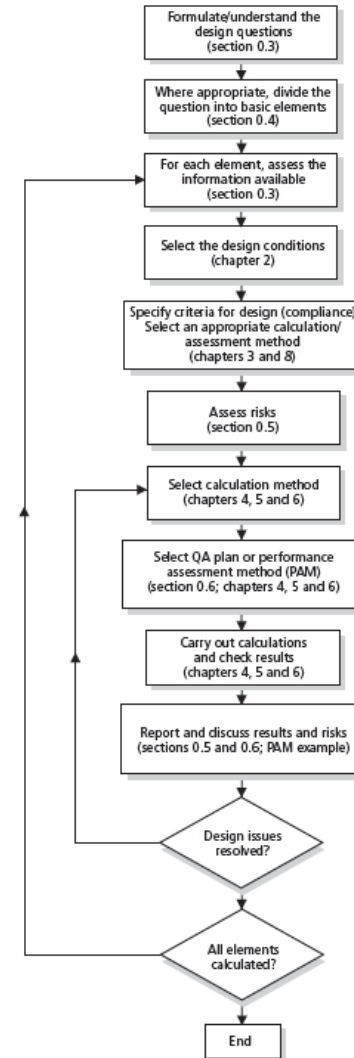



**Fergus Nicol**  
**Oxford Brookes University**

# Chapter 1 - Environmental Criteria for Design



# Purpose of Chapter 1

This chapter is intended to delineate the environments that building occupants will find comfortable.

The interaction between people and buildings takes place in a number of ways, and many aspects of the environment are important:

- the thermal environment (both inside the building and outside)
- the lighting
- the ventilation
- any noise or vibration.

**The chapter brings together information in all these aspects and tries to give the best and most up-to-date information on which building services engineers can base their designs.**

# Thermal environment and comfort

Largely rewritten in the main with sections on

- Comfort
- Thermal environment, defining variables and looking at the 6 basic variables
- Models of thermal comfort – adaptive and PMV. How they are derived, how they differ and what they have in common
- Environmental criteria for indoor spaces.

# Thermal environment and comfort

Overheating: reflecting the criteria for overheating introduced in TM52

Additional factors affecting comfort including **personal factors** such as age, gender, state of health as well as **environmental factors** such as asymmetry, floor temperatures, draughts and turbulence and the influence of other dimensions such as lighting on thermal comfort.

Each section reviews the available evidence and its reliability

# Outdoor thermal comfort

An entirely new section which addresses the importance of the outdoor environment and how it can be optimised

## Requirements for outdoor air

Looks at the need for fresh air and how it can be affected by the rate of supply and the need to control pollutants. Indoor Air Quality is addressed in chapter 8

# Noise and Vibration

Two sections have been thoroughly rewritten

- Noise deals with the measurement and effect of noise viewing sound both as a means of communication and as a source of discomfort. The section give plentiful references to guidelines and standards
- Vibration is dealt with from the point of view of the danger is poses to buildings and their occupants dealing with sources as well as consequences

# Visual environment

Lighting for Safety and visual performance

The criteria for daylighting and the role of energy efficiency in lighting

This section has been shortened and readers are referred to the publications of the SLL

## References

There is a copious list of references which can be used for further reading

Table 1.5 Recommended comfort criteria for specific applications

Building/room type	Customary winter operative temperatures for stated activity and clothing levels*			Customary summer operative temperatures (air conditioned buildings†) for stated activity and clothing levels*			Suggested air supply rate / (L·s <sup>-1</sup> per person unless stated otherwise)	Filtration grade‡	Maintained illuminance§ / lux	Noise criterion§		
	Temp. /°C	Activity /met	Clothing /clo	Temp. /°C	Activity /met	Clothing /clo				NR	dBA§	dB(C)§
<b>Airport terminals:</b>												
— baggage reclaim	12–19 <sup>[1]</sup>	1.8	1.2	21–25	1.3	0.6	10 <sup>[2]</sup>	F6–F7	200	45	50	75
— check-in areas <sup>[3]</sup>	18–20	1.4	1.2	21–25	1.3	0.6	10 <sup>[2]</sup>	F6–F7	500 <sup>[4]</sup>	45	50	75
— concourse (no seats)	19–24 <sup>[1]</sup>	1.8	1.2	21–25	1.3	0.6	10 <sup>[2]</sup>	F6–F7	200	45	50	75
— customs area	18–20	1.4	1.2	21–25	1.3	0.6	10 <sup>[2]</sup>	F6–F7	500	45	50	75
— departure lounge	19–21	1.3	1.2	22–25	1.2	0.6	10 <sup>[2]</sup>	F6–F7	200	40	45	70
<b>Art galleries — see Museums and art galleries</b>												
<b>Banks, building societies, post offices:</b>												
— counters	19–21	1.4	1.0	21–25	1.3	0.6	10 <sup>[2]</sup>	F6–F7	500	35–40	40–45	65–70
— public areas	19–21	1.4	1.0	21–25	1.3	0.6	10 <sup>[2]</sup>	F5–F7	300	35–45	40–45	65–70
<b>Bars/lounges</b>	20–22	1.3	1.0	22–25	1.3	0.6	10 <sup>[2]</sup>	F5–F7	100–200 <sup>[5]</sup>	30–40	35–45	60–70
<b>Bus/coach stations — see Railway/coach stations</b>												
<b>Churches</b>	19–21	1.3	1.2	22–25	1.3	0.6	10 <sup>[2]</sup>	G4–F6	100–200	25–30 <sup>[6]</sup>	30–35	55–60
<b>Computer rooms<sup>[7]</sup></b>	19–21	1.4	1.0	21–25	1.3	0.6	10 <sup>[2]</sup>	F7–F9	300	35–45	40–50	65–75
<b>Conference and rooms</b>	22–23	1.4	1.0	23–25	1.1	0.6	10 <sup>[2]</sup>	F6–F7	300/500 <sup>[8]</sup>	25–30	30–35	55–60
<b>Drawing offices</b>	19–21	1.4	1.0	21–25	1.3	0.6	10 <sup>[2]</sup>	F7	750	35–45	40–50	65–75
<b>Dwellings:</b>												
— bathrooms	20–22	—	—	23–25	—	—	15 L·s <sup>-1</sup>	G2–G4 (extract) <sup>[9]</sup>	150 <sup>[4]</sup>	—	—	—
— bedrooms	19–21	—	—	21–25	—	—	0.4 CFM <sup>10</sup> control moisture	—	100 <sup>[4]</sup>	25	30	55
— hall/stairs/landings	19–24 <sup>[1]</sup>	—	—	21–25 <sup>[1]</sup>	—	—	—	—	100	—	—	—
— kitchen	17–19	1.6	1.0	21–25	1.5	0.5	60 L·s <sup>-1</sup>	G2–G4 (extract) <sup>[9]</sup>	150–300	40–45	45–50	70–75
— living rooms	22–23	1.1	1.0	23–25	1.1	0.6	0.7 ACH control moisture <sup>[9]</sup>	G2–G4	50–300	30	35	60
— toilets	19–21	—	—	21–25	—	—	>5 ACH	G2–G4	100 <sup>[4]</sup>	—	—	—
<b>Educational buildings:</b>												
— corridor	19–21	1.4	1.0	21–25	1.3	0.6	10 <sup>[2]</sup>	— <sup>[11]</sup>	100	35–45	40–50	65–75
— gymnasium	—	—	—	—	—	—	—	—	300	35–45	40–50	65–75
— laboratory	19–21	1.4	1.0	21–25	1.3	0.6	10 <sup>[2]</sup>	— <sup>[17]</sup>	100	35–40	40–45	65–70
— lecture halls <sup>[10]</sup>	19–21	1.4	1.0	21–25	1.3	0.6	10 <sup>[2]</sup>	G4–G5	500 <sup>[11]</sup>	25–30	30–40	55–65
— seminar rooms	19–21	1.4	1.0	21–25	1.3	0.6	10 <sup>[2]</sup>	G4–G5	300 <sup>[11]</sup>	25–35	30–40	55–65
— teaching (lecture)	19–21	1.4	1.0	21–25	1.3	0.6	10 <sup>[2]</sup>	G4–G5	300 <sup>[11]</sup>	25–35	30–49	55–65
— workshop	16–19	1.8	0.9	— <sup>[13]</sup>	—	—	— <sup>[14]</sup>	Depends on use	— <sup>[13,16]</sup>	35–40	40–45	65–70
<b>Exhibition halls</b>	19–21	1.4	1.0	21–25	1.3	0.6	10 <sup>[2]</sup>	G3–G4	300	40	45	60

**Table 1.5 (pages 1-10 to 1-13) draws together the recommended values for temperatures, air supply and filtration, illuminance and noise levels for different building types and spaces**

Table continues



# Contributors

**Thermal environment and thermal comfort** (Michael Humphreys and F.N.)

**Outdoor thermal comfort** (M.N.)

**Air supply** (Martin Liddament)

**Visual environment** (David Loe, Mike Wilson and Peter Tragenza)

**Noise and Vibration** (Bob Peters and John Shelton)

# Geoff Levermore University of Manchester

## Chapter 2 - External Design Data



# Updates and new data in A2

## External design data

Probabilistic climate profiles (ProCliP) graphs give an appreciation of the temperature rises through the century for different emissions scenarios.

The urban heat island (UHI) data has been updated to give the UHI effect for the City of London and various distances out from it compared to Heathrow. Manchester data is also provided.

# 14 stations, full data including solar

Belfast	Aldergrove	Manchester Ringway,	Woodford
Birmingham	Elmdon Coleshill	Newcastle Newcastle WC,	Albermarle
Cardiff	Rhoose, St Athan	Norwich	Marham
Edinburgh	Turnhouse ,Gogarbank	Nottingham	Watnall
Glasgow	Abbotsinch, Bishopton	Plymouth	Mountbatten
Leeds	Church Fenton	Southampton	Hurn
London	Heathrow	Swindon	Brize Norton

# Details of the climate of the 14 stations mean annual and summer temps

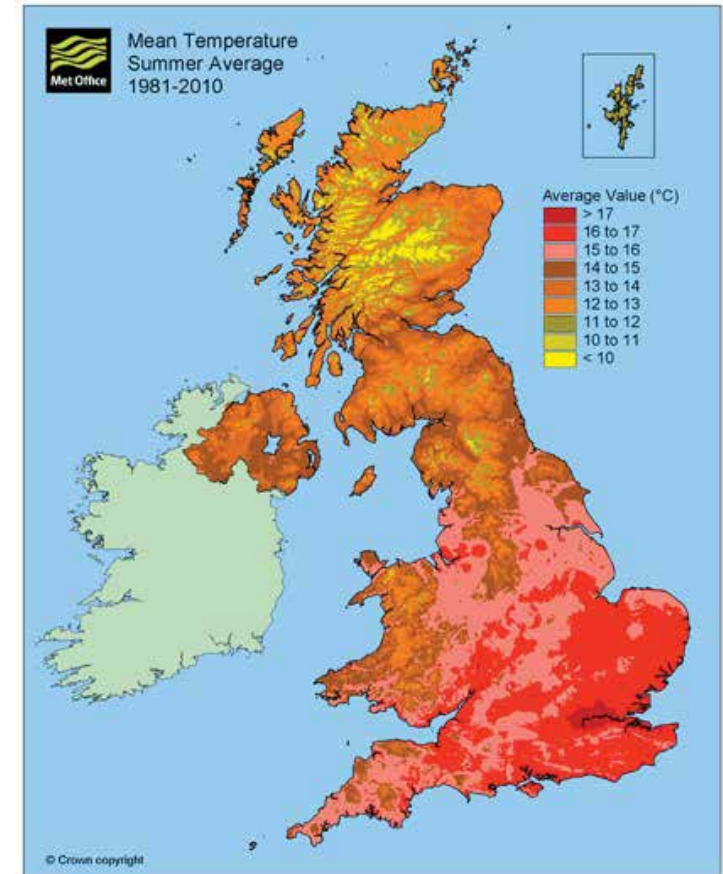
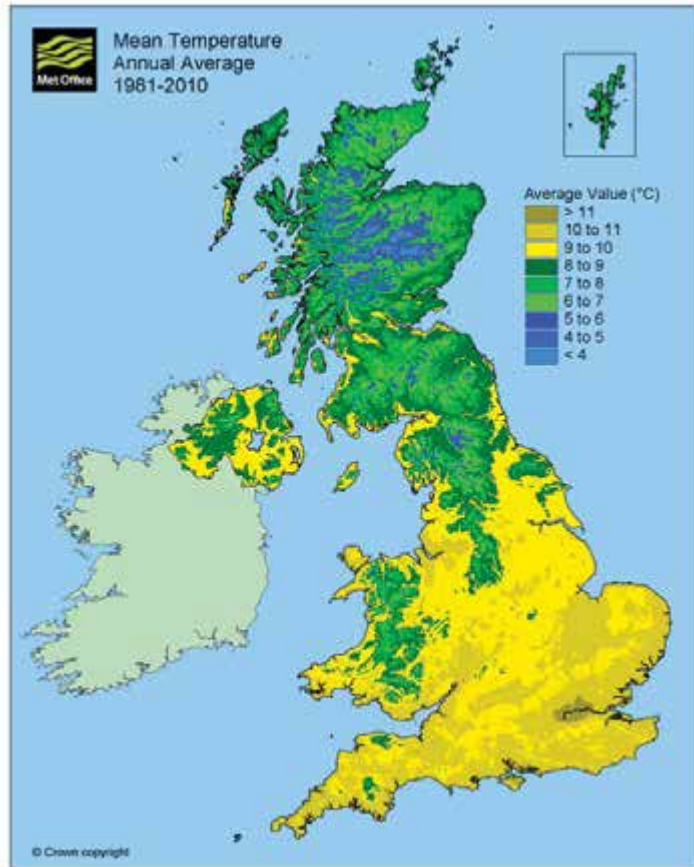

# Updated cold and warm weather data as well as wet & dry bulb temps

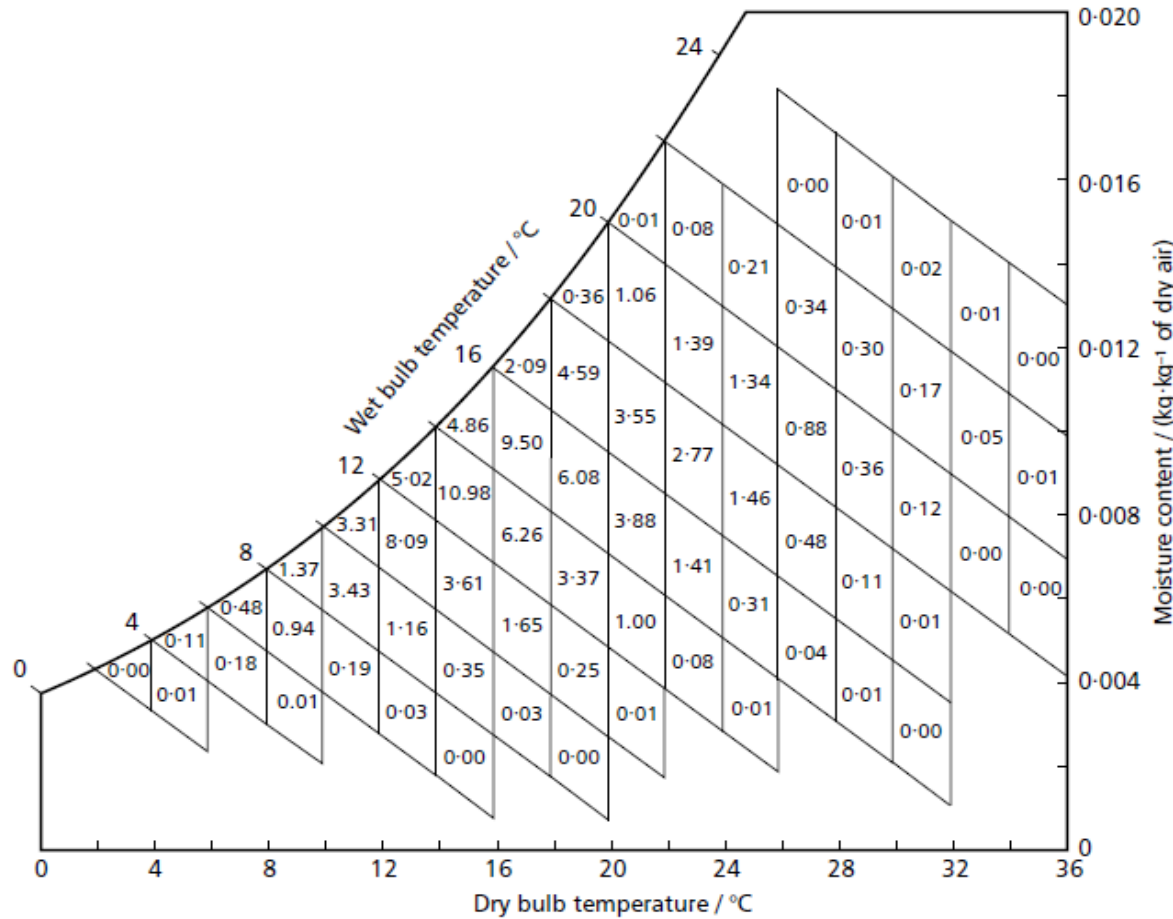

Figure 2.3(g) Percentage frequencies of wet and dry bulb temperatures, June–September, plotted on a psychrometric chart: London (Heathrow) (1982–2011)

# Updated solar for 14 sites with simpler sol-air temp

$I_{\text{Thd}}$  = global hor irradi

For horizontal surfaces:

$$I_1 = 93 - 79 C \quad (2.1)$$

For vertical surfaces:

$$I_1 = 21 - 17 C \quad (2.2)$$

where  $I_1$  is the long wave radiation loss and  $C$  is the cloudiness.

The maximum sol-air temperature ( $\theta_{\text{eo}}$ ) for a horizontal surface (having solar absorptance  $\alpha = 0.9$  and long-wave emissivity  $\varepsilon = 0.9$ ) would be given by the following:

$$\theta_{\text{eo}} = (\alpha I_{\text{Thd}} - \varepsilon I_1) R_{\text{se}} + \theta_{\text{ao}} \quad (2.3)$$

# Updated wind (1 knot = 0.51 ms<sup>-1</sup>)

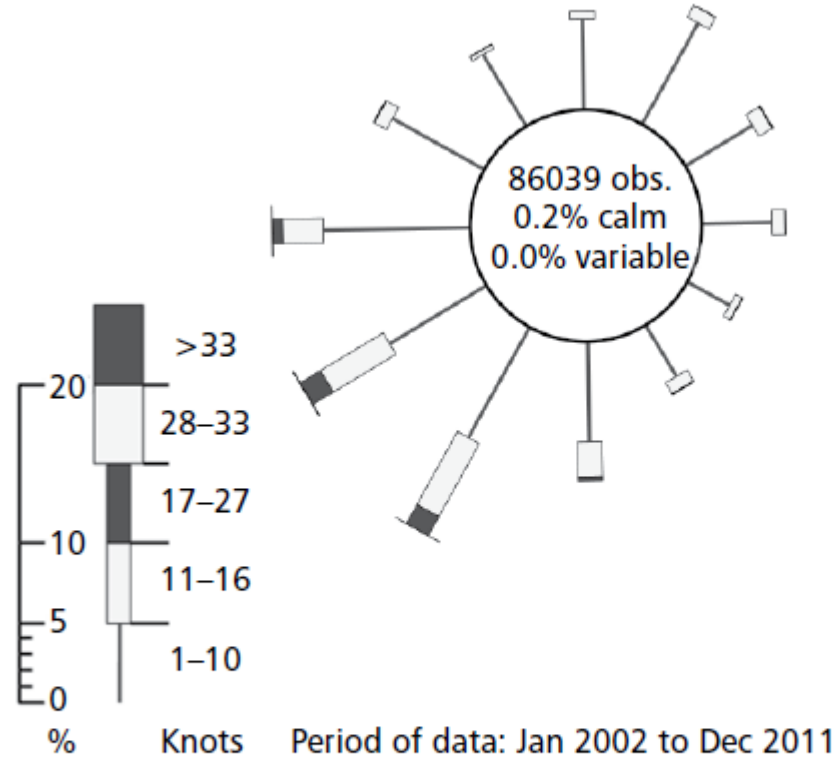

Figure 2.8(g) Wind rose for London (Heathrow); similar wind roses for 14 UK locations may be downloaded from the CIBSE website (<http://www.cibse.org/Guide-A/pdfs>)



# Climate change data and charts

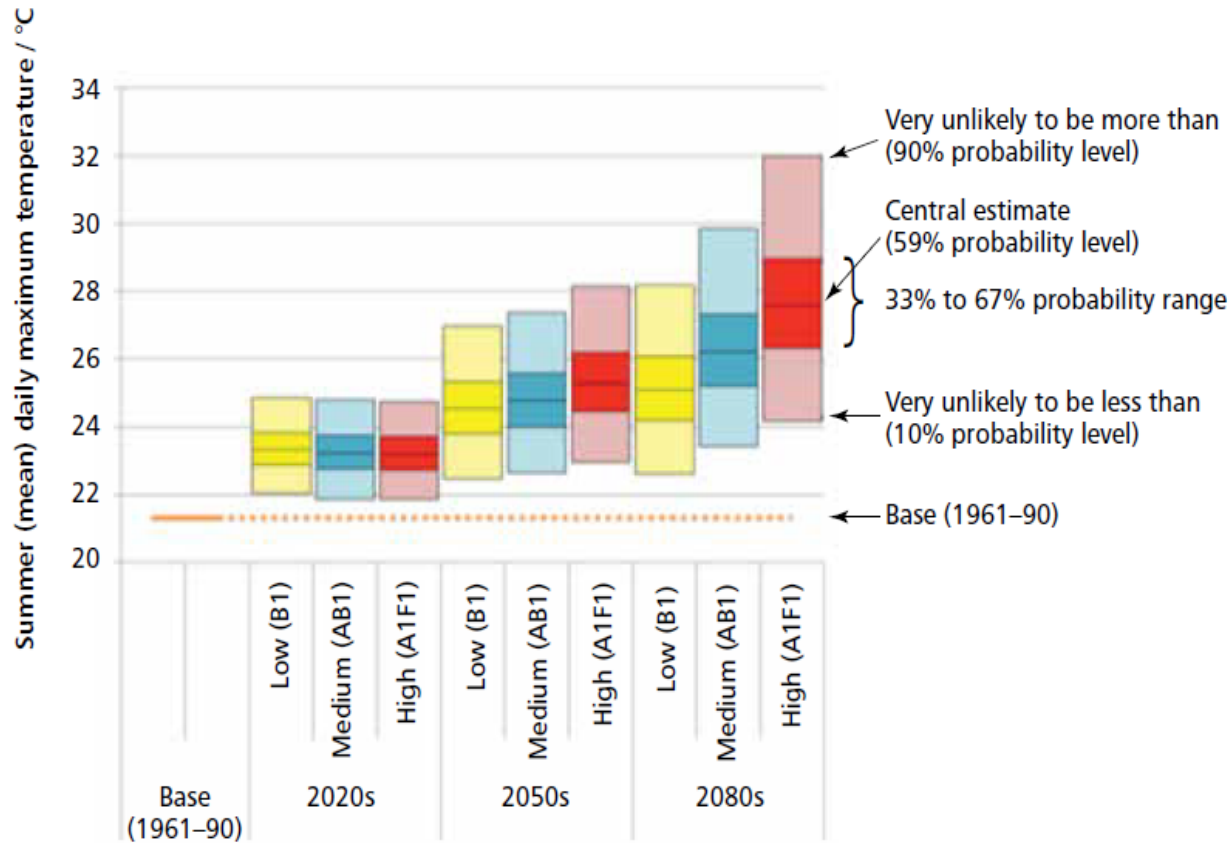
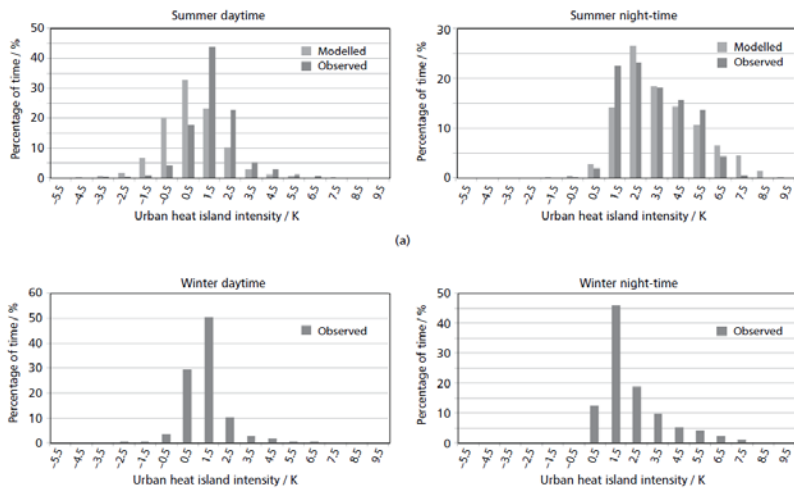

Figure 2.12 Probabilistic climate profile (ProCliP): London summer (Jun, Jul, Aug) mean daily maximum temperatures (Shamash et al., 2012)

# Urban heat island intensity (UHII)

UHII is the extra temperature rise in the urban area compared to the rural area. For the CIBSE data the UHII is relative to Heathrow and near Manchester airports. Add on the UHII factors (from CIBSE tables) to the so-air temperatures.

## London



## Manchester

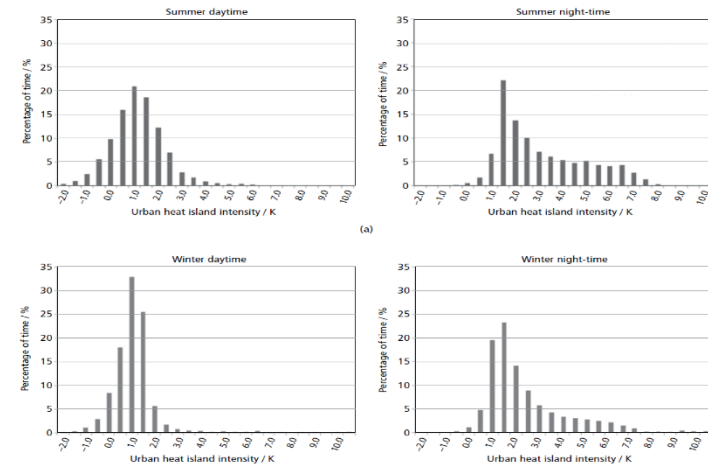

**Brian Anderson**  
**BRE Scotland**

## Chapter 3 – Thermal properties of Building Structures



# Thermal properties of building structures

- Chapter 3 covers the determination of heat transmission properties of building elements – walls, floors, roofs, windows.
- It provides methods of calculation and associated data on the thermal conductivity of materials.

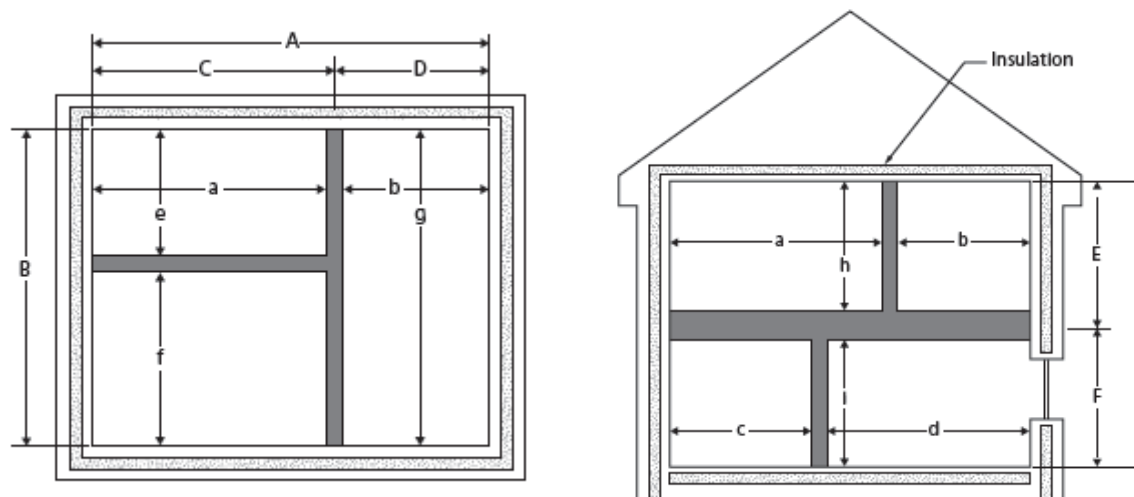

Figure 3.1 Dimensions for heat loss calculations



# Multifoil insulation

- Products that consist of several layers of foil separated by other materials
- New British Standard (BS EN 16012) which defines how to measure and declare insulation properties

# U-values of elements with inhomogeneous layers

Bridged elements are assessed using the mid-way point of the upper and lower limits of thermal resistance.

Now a maximum of 1.5 for the ratio of the two limits for the result to be considered valid.

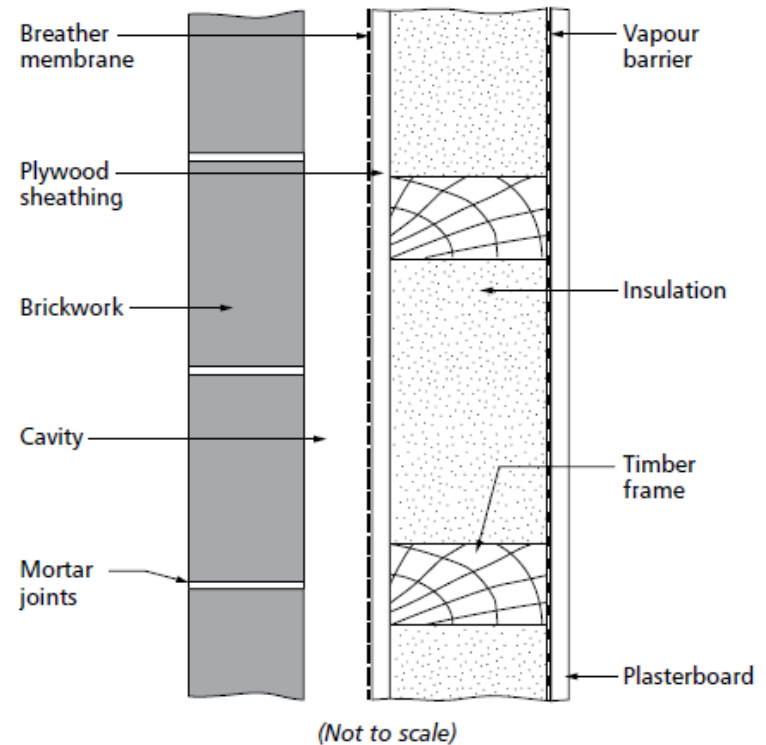

# Blinds, curtains and secondary glazing

Revised data:

**Table 3.27** Thermal resistance of blinds, curtains and secondary glazing

Description	Thermal resistance (m <sup>2</sup> ·K/W)
Heavy curtains	0.16
Well-fitting shutters	0.33
Roller blind	0.14
Roller blind with low emissivity film facing towards the outside	0.3
Honeycomb insulated blind	0.24
Secondary glazing	0.18
Low emissivity secondary glazing	0.32
Low emissivity secondary glazing and shutters	0.39

# Windows and roof windows

Revised data, including:

- Gas filling between panes
- Low emissivity of glass surfaces
- Different frame types
- Effect roof pitch for roof windows

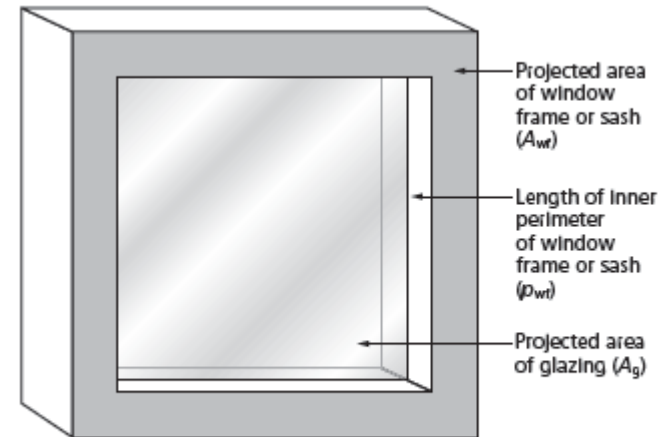

Figure 3.15 Dimensions of window for calculation purposes



# Thermal by-passes

- Can be a significant cause of heat loss
- Provides data for unfilled cavity party walls connected to cold loft space (assigning a U-value to the party wall)
- Future research may provide more detailed information

**Table 3.32** *U*-values for party walls

Party wall construction	<i>U</i> -value (W/m <sup>2</sup> ·K)
Solid (including structurally insulated panel)	0.0
Unfilled cavity with no effective edge sealing	0.5
Unfilled cavity with effective sealing around all exposed edges and in line with insulation layers in abutting elements	0.2
Unfilled cavity where the party wall is closed at ceiling level by a robust construction element such as a concrete floor slab (not a mineral wool cavity barrier)	0.2
Fully filled cavity with effective sealing at all exposed edges and in line with insulation layers in abutting elements	0.0

# Thermal bridging

- Of potentially increasing significance as insulation of structures is raised
- Heat loss calculations should include the effect of thermal bridges and the Guide indicates how they can be evaluated

**Martin Liddament**  
**VEETEC Ltd**



## Chapter 4 – Ventilation and Infiltration



# Chapter 4 Ventilation and Air Infiltration

**At the time of preparation issues about the future of ventilation methods and the impact of infiltration on energy consumption were important.**

**Considerations included:**

-  **Airtightness – Legal requirements to reduce CO2 emissions**
-  **Ventilation more mechanised to provide control**
-  **The Future of Natural Ventilation**

# Background: The Future of Natural Ventilation

## Building Regulations

*(June 2009 Consultation Volume 1)*

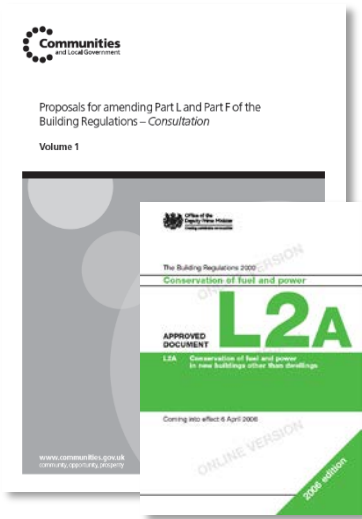

**“It is likely to become more challenging to provide adequate ventilation rates using natural ventilation systems and this will give impetus to mechanical ventilation systems”.**

## NHBC (2012)

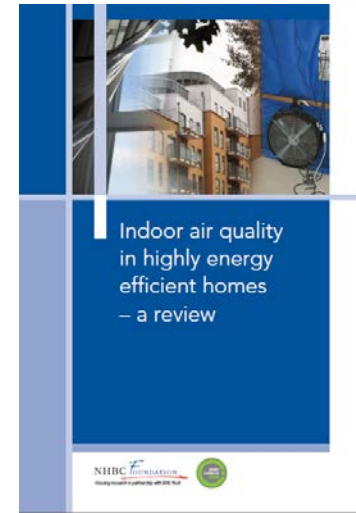

**“In order to satisfy the energy use demands of the Code for Sustainable Homes in homes built to Code Level 4 and above, it is expected that mechanical ventilation with heat recovery will need to be applied in order to achieve an acceptable indoor climate, which represents something of a culture change in the UK.**

# However...



The Carbon Trust: “A typical air conditioned building has double the energy cost and associated CO<sub>2</sub> emissions of a naturally ventilated building. It is also more likely to have increased capital and maintenance costs”.



The Commission for Architecture and the Built Environment (responsible for UK secondary school design): “



Saving Carbon – Improving Health

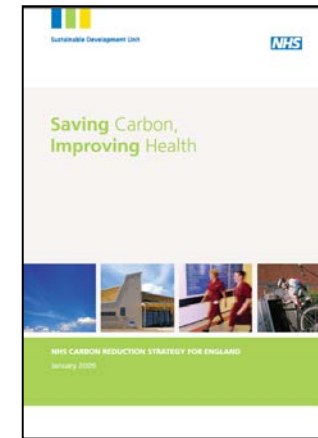

“Buildings designed with passive ventilation have improved resilience to energy supply failure and are more energy efficient than mechanically ventilated buildings. In an acute hospital up to 70% of net floor space could be entirely or partially naturally ventilated”.

# Background: Outcome



**Still a strong demand for buildings to be naturally ventilated**



**Much progress on the implementation of mechanical systems in buildings that were formerly naturally ventilated (e.g. dwellings)**

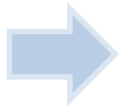

**Many lessons still to be learnt about ventilation performance in practice and about the impact of airtightness**



**A continuing need to consider all aspects of air infiltration and ventilation in Guide A**

# Proposed Structure and Content

- ➔ **Maintain as much of the existing information as possible**
- ➔ **Extend information on mechanical systems**
- ➔ **Update information on airtightness (air permeability) and testing.**
- ➔ **Cover ventilation related air quality issues**



# What is in the Chapter 4 of the CIBSE Guide?

- **An attempt to give a basic understanding with simple tools that can be set up on a spread sheet.**
- **Includes:**
  - **Basic theoretical concepts WITH limitations**
  - **Airtightness (air permeability testing)**
  - **Mechanical ventilation**
  - **Heat recovery**
  - **Natural ventilation and infiltration including wind, stack and combined wind and stack driving forces**
  - **Single sided ventilation**
  - **Terrain conditions**
  - **Sheltering**
  - **Variability and control of ventilation systems**
  - **Basic calculations**
  - **Dilution equation**
  - **Relevant Data**

# Mechanical Systems

- System Type
- Displacement Ventilation
- Mixing Ventilation
- Heat Recovery
- Filtration
- Heating/Cooling
- Specific Fan Power

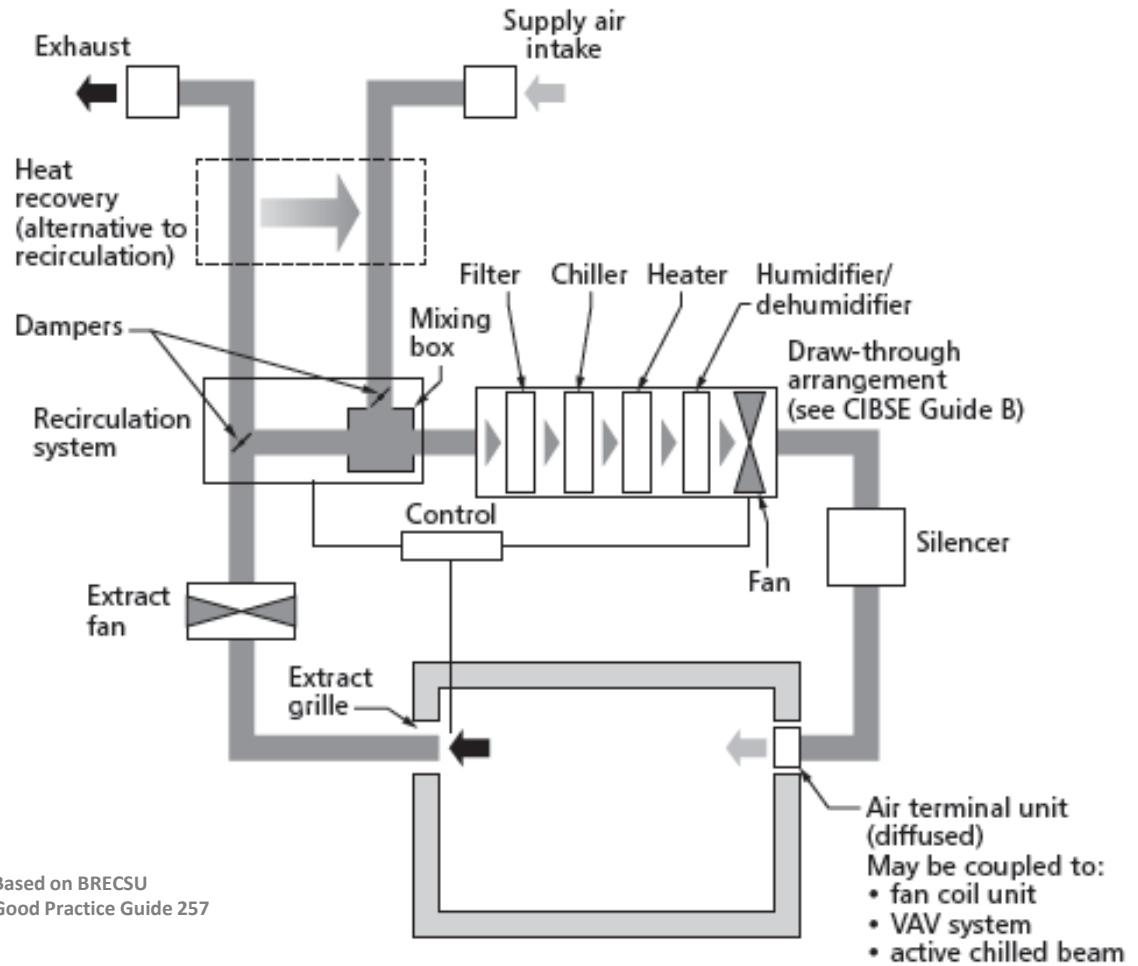

# Natural Ventilation Systems

- System Type
- Weather Parameters
- Variability of Driving Forces
- Calculation Methods

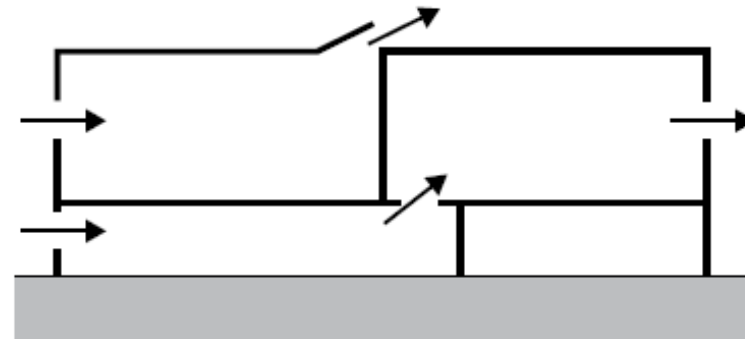
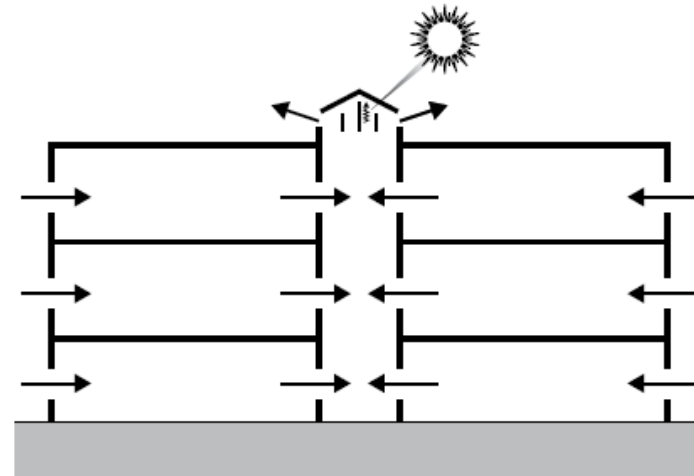

Based on BRECSU  
Good Practice Guide 257

# Calculating Ventilation Rate

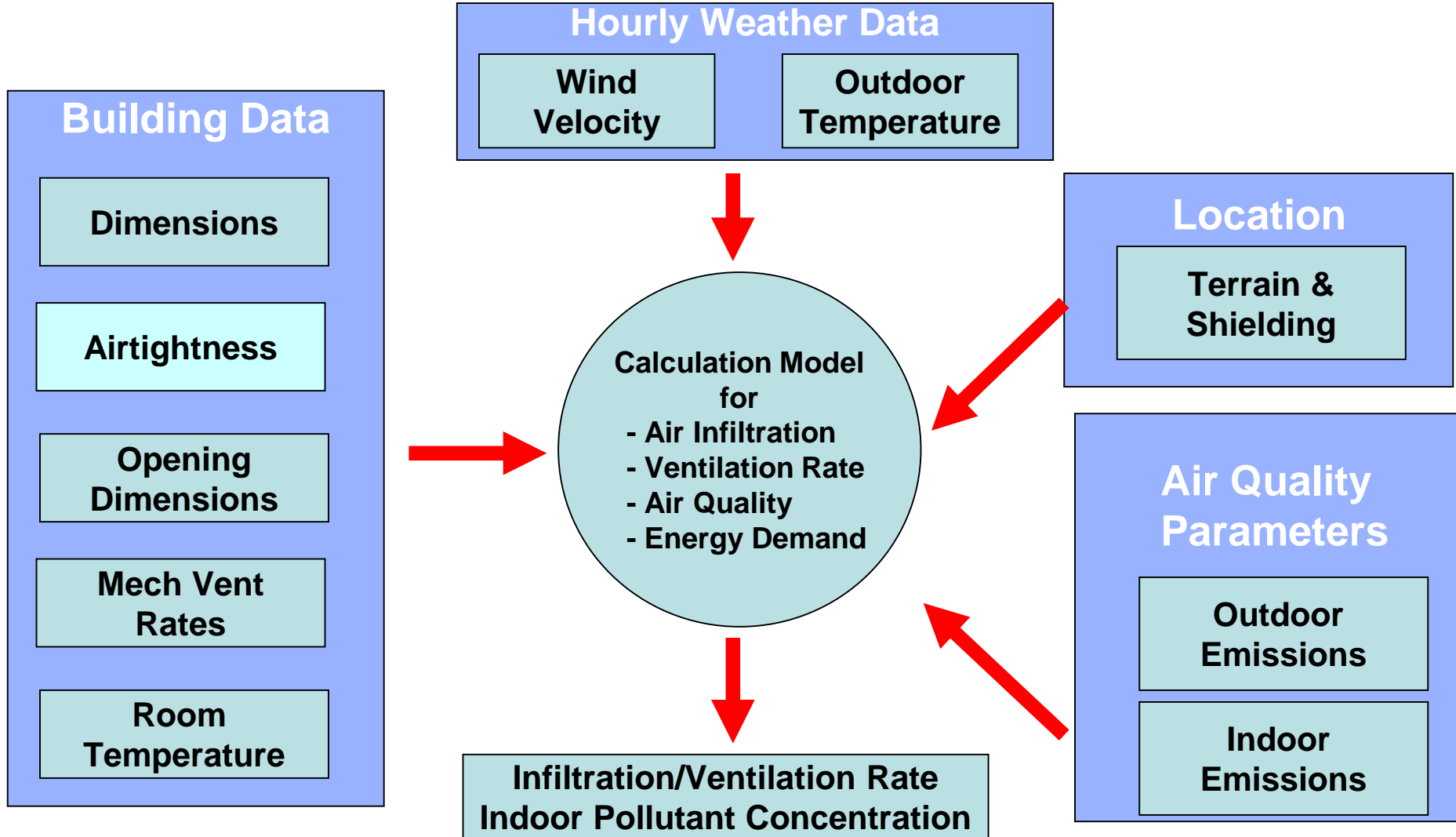

# Variability of Natural Driving Forces

8760 hours of data in a year  
Ideally need to carry out an hourly analysis. Only possible with simple calculation techniques

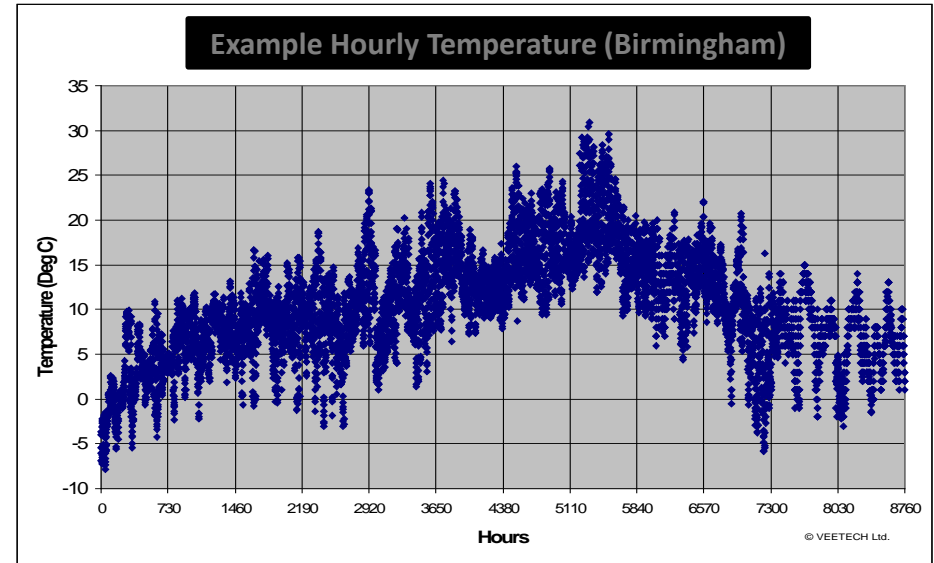
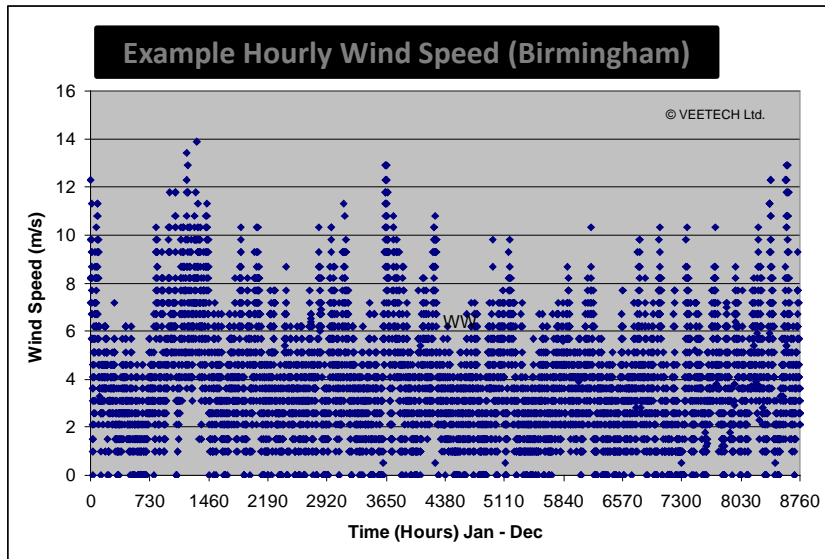

# Can use hourly wind and temperature weather data from Chapter 2

**Table 2.20(g)** Annual and seasonal average percentage frequencies of hourly wind speed by temperature: London (Heathrow) (1982–2011)

Temperature / °C	Percentage frequency for stated range of wind speed / m s <sup>-1</sup>														All speeds		
	0–2	2–4	4–6	6–8	8–10	10–12	12–14	14–16	16–18	18–20	20–22	22–24	24–26	26–28		28–30	30–32
<b>Annual average</b>																	
–12.0 to –10.1																	0.01
–10.0 to –8.1	0.01	0.00	0.00														0.03
–8.0 to –6.1	0.02	0.01	0.01														0.17
–6.0 to –4.1	0.10	0.04	0.02	0.01	0.00												0.56
–4.0 to –2.1	0.27	0.16	0.07	0.04	0.02	0.00											1.67
–2.0 to –0.1	0.84	0.52	0.20	0.08	0.03	0.00											3.64
0.0 to 1.9	1.60	1.29	0.54	0.17	0.03	0.00											5.96
2.0 to 3.9	2.22	2.16	1.13	0.39	0.06	0.01											8.20
4.0 to 5.9	2.55	3.14	1.76	0.58	0.15	0.02	0.00										10.19
6.0 to 7.9	2.79	3.87	2.35	0.86	0.26	0.05	0.01	0.00									11.88
8.0 to 9.9	2.73	4.35	2.98	1.26	0.43	0.10	0.02	0.00	0.00								12.52
10.0 to 11.9	2.74	4.42	3.09	1.53	0.55	0.15	0.03	0.01	0.00								11.66
12.0 to 13.9	2.84	4.19	2.79	1.25	0.43	0.12	0.03	0.01	0.00	0.00							10.66
14.0 to 15.9	2.45	4.14	2.73	1.02	0.27	0.06	0.01	0.00									8.59
16.0 to 17.9	1.73	3.28	2.47	0.86	0.21	0.04	0.00										6.02
18.0 to 19.9	1.08	2.22	1.83	0.70	0.16	0.03	0.00										3.70
20.0 to 21.9	0.59	1.41	1.14	0.45	0.09	0.02	0.00										2.21
22.0 to 23.9	0.29	0.90	0.72	0.26	0.03												1.26
24.0 to 25.9	0.15	0.54	0.42	0.13	0.01												0.67
26.0 to 27.9	0.06	0.30	0.22	0.08	0.01												0.27
28.0 to 29.9	0.01	0.12	0.10	0.05	0.00												0.12
30.0 to 31.9	0.00	0.04	0.05	0.02	0.00												0.03
32.0 to 33.9		0.01	0.01	0.00													0.01
34.0 to 35.9		0.00	0.00														0.00
36.0 to 37.9			0.00														0.00
All temps.	25.07	37.11	24.62	9.73	2.74	0.60	0.10	0.02	0.01								100.00

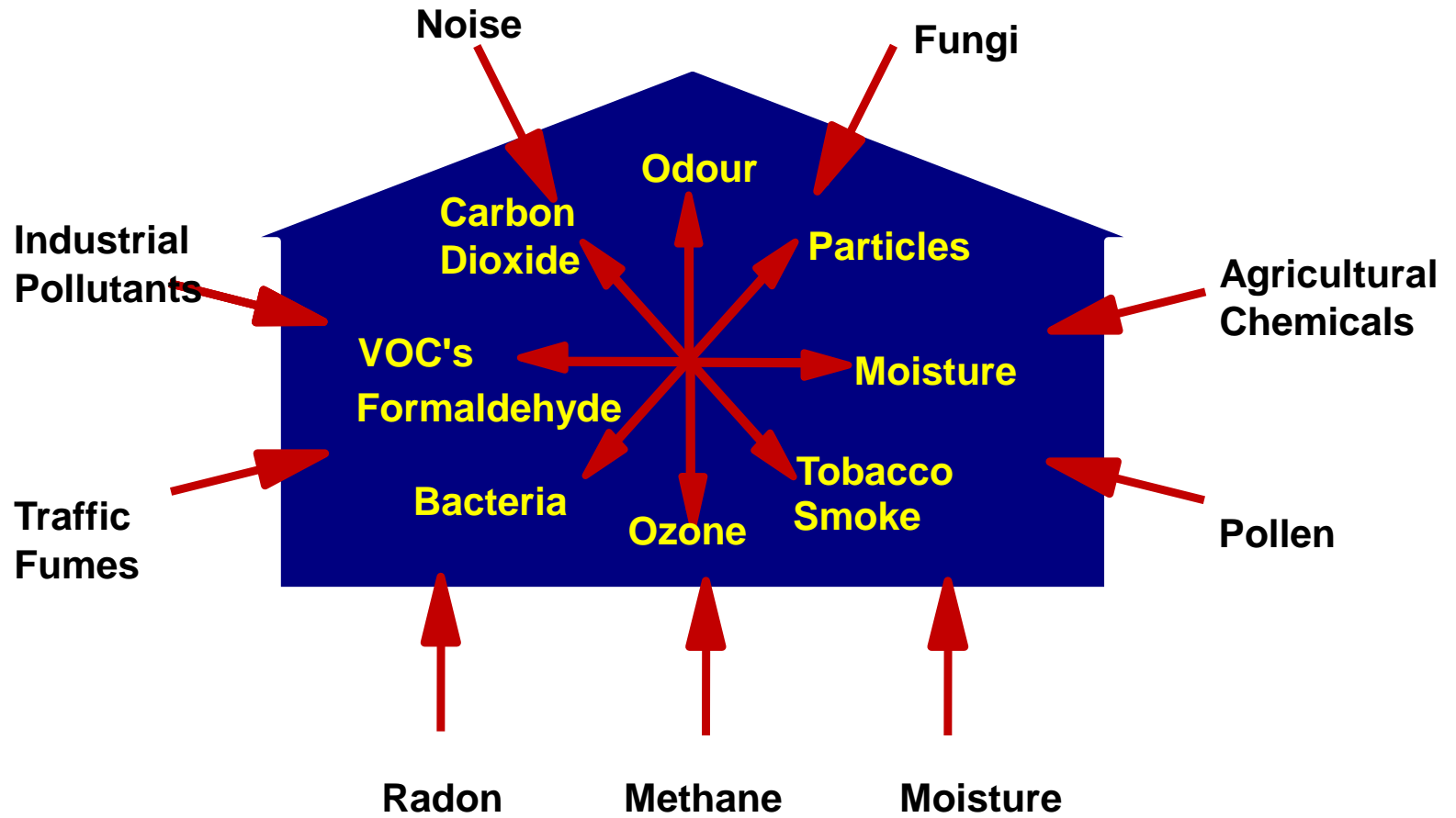

Dilution Equation - Pollutant Removal

$$c_t = \left( \frac{q_v c_0 + q_e}{q_v + q_e} \right) \left[ 1 - e^{-\left( \frac{q_v + q_e}{V} \right) t} \right]$$

# Ventilation Control using Metabolic CO<sub>2</sub>:

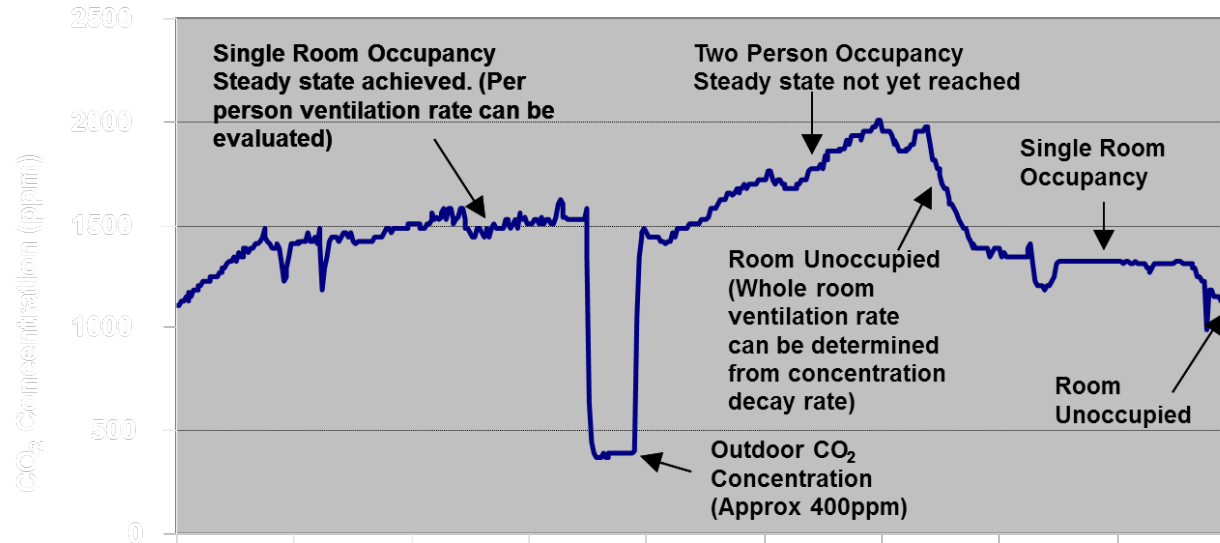

- ➔ CO<sub>2</sub> as a 'Surrogate' for Metabolic Pollution and as a 'Tracer' Gas;
- ➔ Metabolic CO<sub>2</sub> increasingly popular as a 'control' method;
- ➔ Linked to the presence and number of occupants;
- ➔ Relatively easy and inexpensive to measure;
- ➔ Considerable discussion about set-point level;
- ➔ CO<sub>2</sub> concentration has been linked to occupant performance.



# Other Items Related to Ventilation



## Empirical infiltration data for various air permeabilities and building sizes

**Table 4.19** Empirical values for air infiltration rate due to air infiltration for rooms in buildings on normally exposed sites in winter: office type 4 (air conditioned HQ-type building up to 20 storeys); sheltered (up to 4 storeys), partial exposure (up to 12 storeys), exposed (above 12 storeys)

Air permeability / (m <sup>3</sup> /m <sup>2</sup> -h at 50 Pa)	Infiltration rate (ACH) for given floor range / h <sup>-1</sup>											
	< 2 storeys*		< 4 storeys*		< 8 storeys*		< 12 storeys*		< 16 storeys*		< 20 storeys*	
	Peak	Average	Peak	Average	Peak	Average	Peak	Average	Peak	Average	Peak	Average
20.0 (leaky)	0.60	0.34	0.60	0.35	0.65	0.45	0.80	0.50	0.90	0.65	0.95	0.65
10.0 (Part L (2002))	0.30	0.17	0.30	0.20	0.35	0.25	0.40	0.25	0.45	0.35	0.50	0.35
7.0 (Part L (2005))	0.20	0.12	0.25	0.15	0.25	0.15	0.30	0.20	0.35	0.25	0.35	0.25
5.0	0.15	0.08	0.15	0.10	0.20	0.15	0.20	0.15	0.25	0.20	0.25	0.20
3.0	0.10	0.05	0.10	0.05	0.10	0.10	0.15	0.10	0.15	0.10	0.15	0.10
Air change rate at 50 Pa (/ h <sup>-1</sup> )	3.80		2.55		1.95		1.75		1.65		1.55	
ACR <sub>50</sub> divisor	22.3		15.0		8.8		7.2		5.2		4.7	

\* (length × width × height) = 40 m × 25 m × 4 m for each storey (all cases)

Note: tabulated values should be adjusted for local conditions of exposure

# Other Items Related to Ventilation



## Tables of (approximate) wind pressure data

**Table 4.A1.6** Wind pressure coefficient data

Low-rise buildings (up to 3 storeys)

Length to width ratio: 2:1

Shielding condition: highly sheltered (i.e. surrounded by obstructions equivalent to the full height of the building)

Wind speed reference level: building height

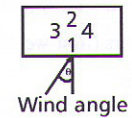

Location	Wind angle								
	0°	45°	90°	135°	180°	225°	270°	315°	
Face 1	0.06	-0.12	-0.2	-0.38	-0.3	-0.38	-0.2	0.12	
Face 2	-0.3	-0.38	-0.2	-0.12	0.06	-0.12	-0.2	-0.38	
Face 3	-0.3	0.15	0.18	0.15	-0.3	-0.32	-0.2	-0.32	
Face 4	-0.3	-0.32	-0.2	-0.32	-0.3	0.15	0.18	0.15	
Roof (> 10°)	Front	-0.49	-0.46	-0.41	-0.46	-0.49	-0.46	-0.41	-0.46
	Rear	-0.49	-0.46	-0.41	-0.46	-0.49	-0.46	-0.41	-0.46
	Average	-0.49	-0.46	-0.41	-0.46	-0.49	-0.46	-0.41	-0.46
Roof (11–30° pitch)	Front	-0.49	-0.46	-0.41	-0.46	-0.4	-0.46	-0.41	-0.46
	Rear	-0.4	-0.46	-0.41	-0.46	-0.49	-0.46	-0.41	-0.46
	Average	-0.45	-0.46	-0.41	-0.46	-0.45	-0.46	-0.41	-0.46
Roof (> 30° pitch)	Front	0.06	-0.15	-0.23	-0.6	-0.42	-0.6	-0.23	-0.15
	Rear	-0.42	-0.6	-0.23	-0.15	-0.06	-0.15	-0.23	-0.6
	Average	-0.18	-0.4	-0.23	-0.4	-0.18	-0.4	-0.23	-0.4

# Other Items Related to Ventilation



## Tables of (approximate) component leakage data

4-36

Ventilation and air infiltration

### Appendix 4.A2: Summary of measured air leakage data

The following tables are reproduced from *A Guide to energy-efficient ventilation* (Liddament, 1996).

**Table 4.A2.1** Leakage characteristics: windows

Type	Flow coefficient, $C$ ( $L \cdot s^{-1} \cdot m^{-1} \cdot Pa^{-n}$ ), and flow exponent, $n$ , for each metre length of joint						Sample size
	Lower quartile		Median		Upper quartile		
	$C$	$n$	$C$	$n$	$C$	$n$	
Windows (weatherstripped):							
— hinged	0.086	0.6	0.13	0.6	0.41	0.6	29
— sliding	0.079	0.6	0.15	0.6	0.21	0.6	19
Windows (non-weatherstripped):							
— hinged	0.39	0.6	0.74	0.6	1.1	0.6	42
— sliding	0.18	0.6	0.23	0.6	0.37	0.6	36
Louvre (expressed per louvre)	—	—	0.34		—	—	1

# Other Items Related to Ventilation

➔ **Simple Algorithm that solves the Ventilation/Infiltration Equation for natural and mechanical driving forces (single zone) sizes.**

## Appendix 4.A3: Air infiltration development algorithm (AIDA)

### 4.A3.1 Introduction

This algorithm was developed by the Air Infiltration and Ventilation Centre (AIVC) and is reproduced here by kind permission of AIVC. CIBSE cannot take responsibility for its accuracy. Any queries regarding the algorithm or its use should be referred to the AIVC.

AIDA is a basic infiltration and ventilation calculation procedure intended for the calculation of air change rates in single-zone enclosures. It also resolves flow rates for any number of user-defined openings and calculates wind and stack pressures. The program is easy to use and provides an accurate solution to the flow balance equation. As its name suggests, this is a development algorithm that may be adapted to suit individual needs. It uses concepts outlined in Chapter 12 of AIVC's *Guide to Energy Efficient Ventilation* (Liddament, 1996).

Care must be taken when entering data since there is no error trapping and no editing facility. It will be necessary to restart the program if an error is made.

As a demonstration algorithm, the input/output routines are rudimentary and may be adapted to suit individual requirements.

### 4.A3.3 Solution technique

The flow balance equation is solved by iteration using a combination of 'bisection' and 'addition'. An internal pressure, known to be substantially negative with respect to the true pressure, is selected as a starting condition. For most applications, a value of  $-100$  Pa should be satisfactory and is introduced automatically at line 320. Successive iterations improve the internal pressure value until a flow balance within  $0.0001 \text{ m}^2\cdot\text{s}^{-1}$  is achieved. The flow balance criterion is established in line 450. An understanding of

**Michael Holmes**  
**Arup**

## Chapter 5 – Thermal Response and Plant Sizing



**David Williams**  
**WSP/Parsons Bickerhoff**

## Chapter 5 – Thermal Response and Plant Sizing



# Chapter 5, Thermal Design Plant Sizing and Energy Conservation

## Introduction

- Current form based on 1999 revision – recognition of design calculation at various levels
- Next revision in 2006 – ‘computerisation’ of the Guide
- 2015 revision
  - Development along similar vein
  - Further coverage on airflow modelling, system simulation and energy calculation
  - Title change from ‘Thermal Design and Plant Sizing’ to ‘Thermal Design Plant sizing and *Energy Conservation*’

# Chapter 5, Thermal Design Plant Sizing and Energy Conservation

- [Michael Holmes](#) (Arup)  
*Principle author*
- [Matthew Collin](#) (MC Building Physics)  
*Examples and the Performance assessment methodology later moved to A0*
- [Malcolm Cook](#) (Loughborough University) and [Darren Woolf](#) (Loughborough University and Hoare Lea)  
*Airflow modelling*
- [Yudish Dabee](#) (Mott MacDonald)  
*Methodology for the calculation of cooling loads*
- [Foroutan Parand](#) (AECOM)  
*Quality management which evolved into A0*
- [Andrew Wright](#) (De Montfort University)  
*Thermal mass also editing early versions*
- [David Williams](#) (WSP|Parsons Brinckerhoff)  
*Energy consumption and technical check*



# Chapter 5, Thermal Design Plant Sizing and Energy Conservation

## Chapter 5 – Examples of New Material

### Air flow modelling

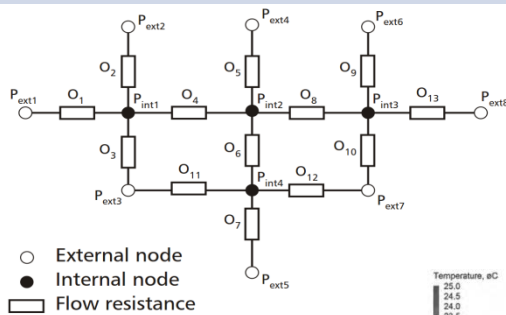

Nodal networks

Computational Fluid Dynamics

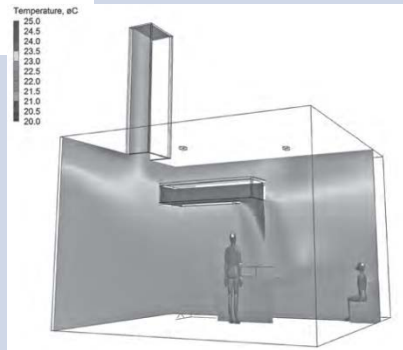

### Component plant modelling

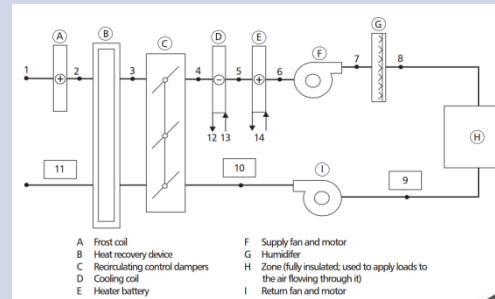

HVAC System Modelling – Psychrometric Modelling

Detailed Component Modelling

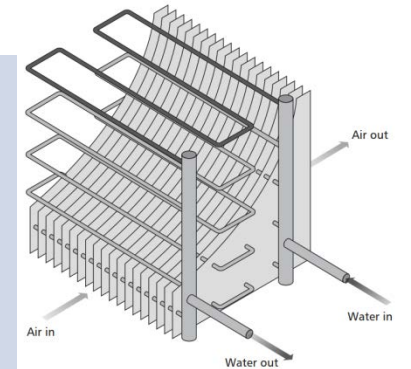

# Chapter 5, Thermal Design Plant Sizing and Energy Conservation

## Chapter 5 – Examples of New Material

### Overheating Risk Calculation

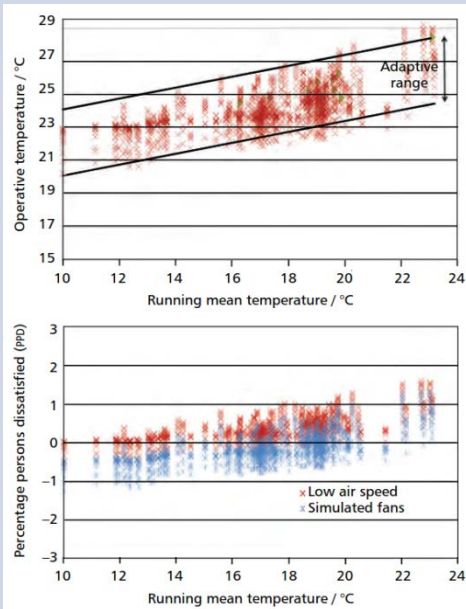

Summertime performance predictions

### Thermal Storage Systems

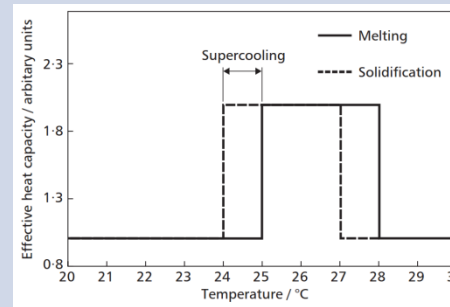

Phase change materials

Ground thermal storage

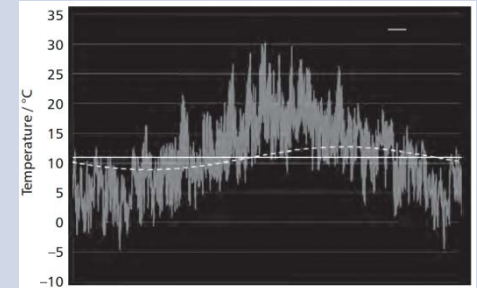

# Chapter 5, Thermal Design Plant Sizing and Energy Conservation

## Chapter 5 – Examples of New Material

### Building Energy Demand

Role and limitations of energy models

Application of calculation methods:

- Annual benchmarking
- Bin methods and degree days
- Quasi-steady state
- Hourly dynamic calculations
  - *Geometry, zoning, climate, materials, solar, ventilation, heat gains, non-thermal, plant*

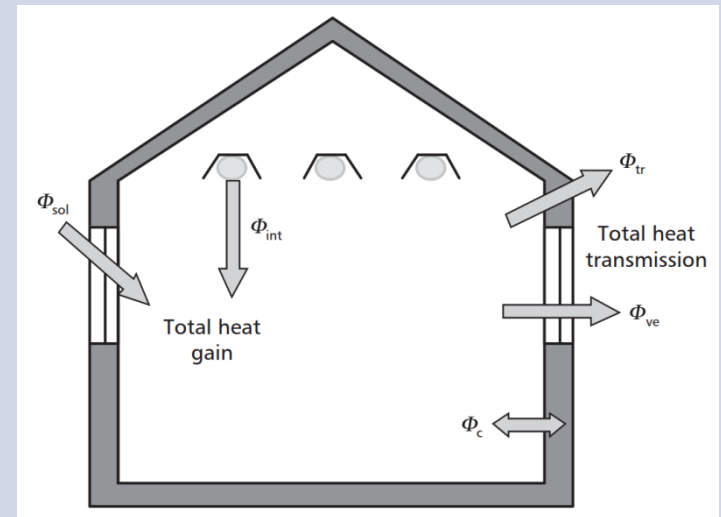

Building heat flow paths

# Chapter 5, Thermal Design Plant Sizing and Energy Conservation

Chapter 5 – Sister Publication

## Application Manual 11 – Building Performance Modelling (AM11)

Due for publication in the next few months  
Refresh of the 1998 manual

- *Quality Assurance*
- *Modelling for Building Energy Regulation*
- *Energy Modelling*
- *Thermal Environment Modelling*
- *Ventilation Modelling*
- *Lighting Modelling*
- *Plant and Renewable Energy Systems*
- *Case Studies*

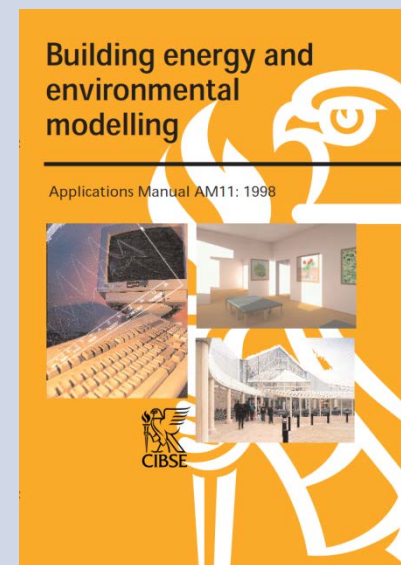

# David Arnold Troup Bywaters + Anders

## Chapter 6 – Internal Heat Gains

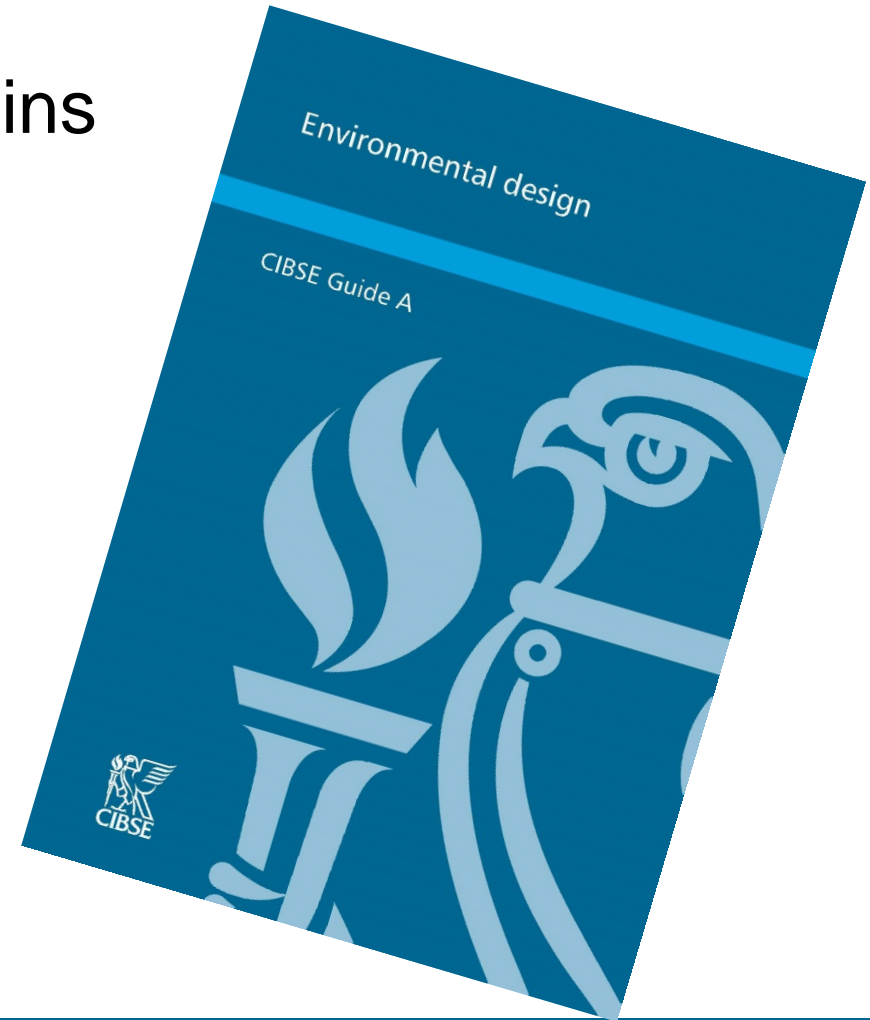

# Environmental Design 2015 Guide A

## Chapter 6 Internal Heat Gains

6 Internal heat gains

6.1 Introduction

6.2 Benchmark values for internal heat gains

6.3 Occupants

6.4 Lighting

6.5 Personal computers and office equipment

6.6 Electric motors

6.7 Cooking appliances

6.8 Hospital and laboratory equipment

6.9 Heat gain from laboratory animals

6.10 Domestic appliances and equipment

References 6-11

Appendix 6.A1: Rate of heat gain from restaurant/cooking equipment 6-13

# Environmental Design 2015 Guide A

## Chapter 6 Internal Heat Gains

- Provides information on heat gains in buildings and guidance for designers to assist them estimating the most appropriate allowances
- Designers can either calculate internal heat gains from basic principles or base them on 'Benchmark' values
- Benchmarks are available for typical buildings and listed in table 6.2

# Environmental Design 2015 Guide A

## Chapter 6 Internal Heat Gains

**Table 6.2** Benchmark allowances for internal heat gains in typical buildings

Building type	Use	Floor area per person / m <sup>-2</sup>	Sensible heat gain / W·m <sup>-2</sup>		
			People	Lighting*	Equipment†
Offices	General	12	6.7	8–12	15
		16	5	8–12	12
	City centre	6	13.5	8–12	25
		10	8	8–12	18
	Trading/dealing	5	16	12–15	40+
	Call centre floor	5	16	8–12	60
	Meeting/conference	3	27	10–20	5
	IT rack rooms	0	0	8–12	200

BCO Guide 2014 Terminal Cooling Small Power Allowance

Conventional Office Density 1:10m<sup>2</sup>

20 W/m<sup>2</sup>

High Density Offices 1:8m<sup>2</sup>

25 W/m<sup>2</sup>



# Environmental Design 2015 Guide A

## Chapter 6 Internal Heat Gains

What's new?

- a) Table showing the estimated heat emission from an adult male body at different temperatures and levels of activity omitted from 2006 edition re-introduced in response to requests;
- b) Heat emitted by office equipment updated to reflect current trends in more efficient models now in use;
- c) Heat emitted by low energy lamps added;
- d) New measurements of the radiative, convective and conductive split of heat from lighting fittings added;
- e) New heat emission from cooking equipment added;
- f) Tables of heat emitted by Hospital and Medical equipment added.

# Environmental Design 2015 Guide A

## Chapter 6 Internal Heat Gains

Table 6.1 Heat emission (W) from an adult male body (of surface area 2 m<sup>2</sup>) and average heat emission per person for a mixture of men, women and children typical of the stated application

Activity	Typical application	Occupancy density (m <sup>2</sup> /person)	Total, sensible and latent heat emission (W) for stated application and dry bulb temperature (C) for adult male (and average for mixture of men, women and children)										
			Total	15		20		22		24		26	
				Sensible	Latent	Sensible	Latent	Sensible	Latent	Sensible	Latent	Sensible	Latent
Seated, inactive	Theatre, cinema matinee	0.75–1.0 <sup>(2,3)</sup>	115 (100)	100 (87)	15 (13)	90 (78)	25 (22)	80 (70)	35 (30)	75 (65)	40 (35)	65 (57)	50 (43)
Seated, inactive	Theatre, cinema evening	0.75–1.0 <sup>(2,3)</sup>	115 (105)	100 (91)	15 (14)	90 (82)	25 (23)	80 (73)	35 (32)	75 (68)	40 (37)	65 (59)	50 (46)
Seated, light work	Restaurant	1.0–2.0 <sup>(2,3)</sup>	140 (126)	110 (99)	30 (27)	100 (90)	40 (36)	90 (81)	50 (45)	80 (72)	60 (54)	70 (63)	70 (63)
Seated, moderate work	Office	8–39 <sup>(4-6)</sup> , 14 <sup>(4,7)*</sup>	140 (130)	110 (102)	30 (28)	100 (93)	40 (37)	90 (84)	50 (46)	80 (74)	60 (56)	70 (65)	70 (65)
Standing, light work, walking	Department store	1.7–4.3 <sup>(2,3)</sup>	160 (141)	120 (106)	40 (35)	110 (97)	50 (44)	100 (88)	60 (53)	85 (75)	75 (66)	75 (66)	85 (75)
Standing, light work, walking	Bank	—	160 (142)	120 (107)	40 (35)	110 (98)	50 (44)	100 (89)	60 (53)	85 (76)	75 (66)	75 (66)	85 (76)
Light bench work	Factory	—	235 (209)	150 (133)	85 (76)	130 (116)	105 (93)	115 (102)	120 (107)	100 (89)	135 (121)	80 (71)	155 (138)
Medium bench work	Factory	—	265 (249)	160 (150)	105 (99)	140 (132)	125 (117)	125 (117)	140 (132)	105 (99)	160 (150)	90 (85)	175 (164)
Heavy work	Factory	—	440 (440)	220 (220)	220 (220)	190 (190)	250 (250)	165 (165)	275 (275)	135 (135)	305 (305)	105 (105)	335 (335)
Moderate dancing	Dance hall	0.5–1.0	265 (249)	160 (150)	105 (99)	140 (132)	125 (117)	125 (117)	140 (132)	105 (99)	160 (150)	90 (85)	175 (164)

\* Recommended

Notes:

(1) Figures in parenthesis are adjusted heat gains based on normal percentage of men, women and children for the applications listed. This is based on the heat gain for women and children of 85% and 75% respectively of that of an adult male.

(2) For restaurant serving hot meals add 10 W sensible and 10 W latent for food per individual.

# Environmental Design 2015 Guide A

## Chapter 6 Internal Heat Gains

Heat emitted by office equipment updated to reflect current trends in more efficient models now in use;

The results of new experimental measurements of heat gain from office equipment including from flat panel monitors. The data is now presented with the radiant convective split. have been carried out by Hosni and Beck (2011). The results are shown in Table 6.6.

# Environmental Design 2015 Guide A

## Chapter 6 Internal Heat Gains

Heat emitted by low energy lamps added;

The Society of Light and Lighting does not recommend the use of LED substitute fluorescent lamps but, at the time of writing, several new fittings that are more energy efficient and offer reasonable quality of light have become available commercially.



# Environmental Design 2015 Guide A

## Chapter 6 Internal Heat Gains

### Key design criteria

**1:8**  
Occupational density

#### Load densities for cooling

- Lighting**  
12W/m<sup>2</sup> infrastructure.
- Small power**  
30W/m<sup>2</sup>.
- Additional tenant equipment allowance**
  - On floor secondary equipment rooms (SERs) 20kW per floor.
  - Main equipment room (MER 625kW total), allocated on a pro rata basis.
- Additional cooling allowance**  
Of up to 50W/m<sup>2</sup>, over 30% of any individual office floor area. (Available upon request).

#### Ventilation and catering facilities

- Outside air rate**  
2 l/s/m<sup>2</sup>.
- Tenant catering facilities**
  - 2 x 850mm x 700mm and 5 other ducts of varying sizes.
  - Up to 16m<sup>2</sup>/s of outside supply air is available for kitchen supply air.
  - 20 l/s allowance per tea point in main extract system (2 no per floor).
  - Dedicated water and drainage connections.
  - Metered gas infrastructure.

#### Air conditioning systems

- Low energy fan coil unit system or Active chilled beam system
- Separate hydraulic on-floor circuits provide full flexibility to tenants.

#### Plant locations

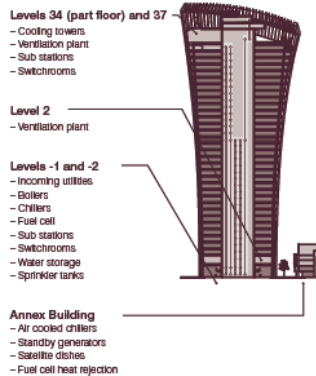

#### Energy and sustainability targets

- Building regulations**  
Approved document Part L2A:2010  
TER 28.4 kgCO<sub>2</sub>/m<sup>2</sup>/annum  
BER 21.6 kgCO<sub>2</sub>/m<sup>2</sup>/annum
- Compliance margin over 2010 Part L regulations of 24.1%.
- BREEAM**  
Excellent when incorporating fit out.
- EPC rating 40.

#### Low zero carbon (LZC) technologies

- 300kW (electrical output) fuel cell**  
6.6% CO<sub>2</sub> reduction
- Roof mounted PVs**  
Predicted to generate 27300 kWh per year

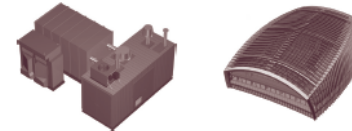

#### Power, cooling and resilience strategy

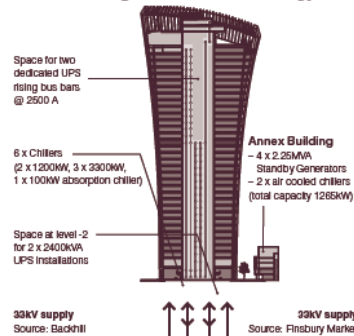

#### BMS, fire alarm & metering strategy

- Type L1 analogue addressable fire alarm system with fully integrated voice alarm.
- Centralised Building Management System.
- Comprehensive energy metering system.

# Environmental Design 2015 Guide A

## Chapter 6 Internal Heat Gains

### 20 Fenchurch Street

#### Load densities for cooling

##### Lighting

12W/m<sup>2</sup> infrastructure.

##### Small power

30W/m<sup>2</sup>.

##### Additional tenant equipment allowance

- On floor secondary equipment rooms (SERs) 20kW per floor.
- Main equipment room (MER 625kW total), allocated on a pro rata basis.

##### Additional cooling allowance

Of up to 50W/m<sup>2</sup>, over 30% of any individual office floor area.  
(Available upon request).



# Chris Sanders

## Glasgow Caledonia University

### Chapter 7 – Moisture transfer and Condensation



# Major changes

More emphasis on importance of air movement as a mechanism for moisture transport

Liquid water storage and movement within porous materials forms an essential part of advanced prediction models to BS EN 15026

## Introduction

New paragraphs emphasising the importance of air leakage into structures as a mechanism for moisture transport into fabric, and therefore the need to limit air leakage.



# 7.3 Psychrometry of water vapour in air

Expanded version of previous 7.6.1, with simple psychrometric chart to explain derivation of parameters.

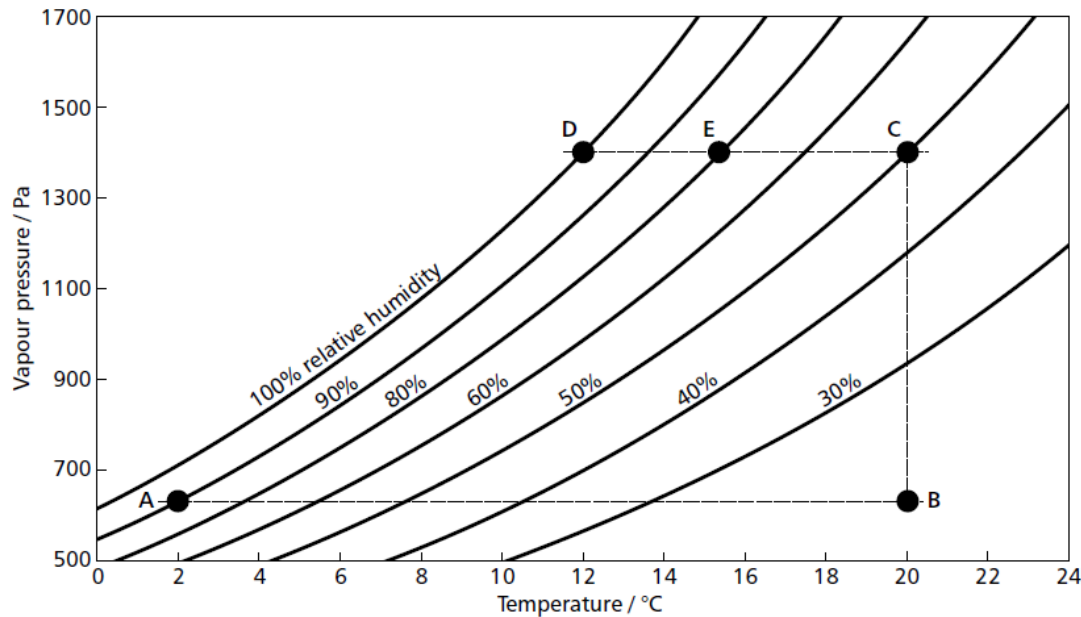

# 7.4 Moisture content of materials

Equation for sorption isotherm, relating moisture content of material to the ambient RH introduced. Parameters of the equation introduced to expanded Table 7.1

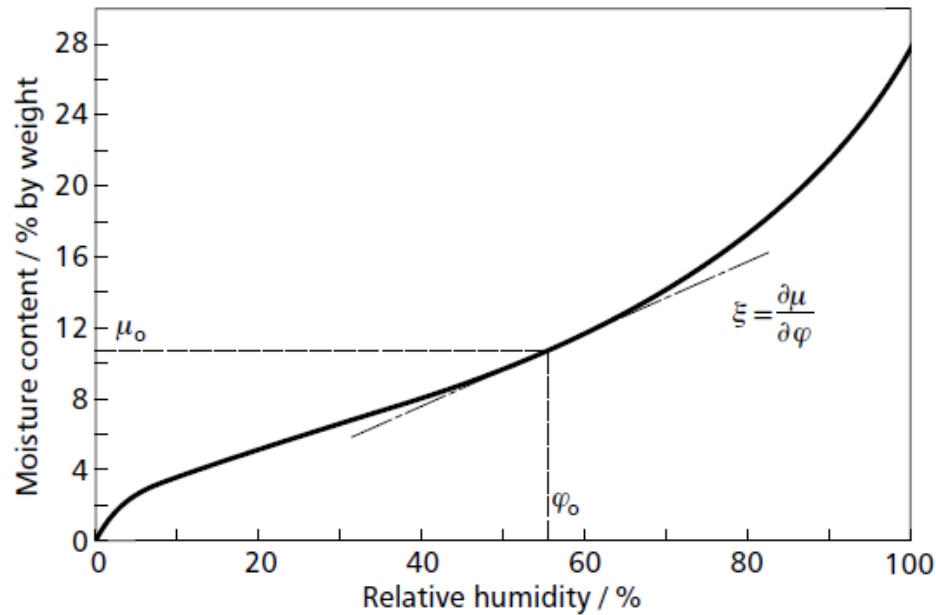

Figure 7.2 Sorption curve with indication of moisture capacity

# 7.5 Mechanisms of moisture movement

New section 7.5.3 discussing role of surface buffering in controlling internal humidity.

New section 7.5.5 discussing liquid water movement through pores, which is the dominant mechanism in the more advanced models under BS EN 15026.

Section 7.5.6 on air movement expanded.

## 7.5.5 Liquid water movement

The pressure acting on the water inside a building material due to the capillary forces is different from the pressure of the surrounding air, i.e:

$$p_{\text{suc}} = P - p_w \quad (7.21)$$

where  $p_{\text{suc}}$  is the suction pressure (Pa),  $P$  is the pressure of the surrounding air (Pa) and  $p_w$  is the pressure of the water in a pore of the material (Pa).

This difference, the suction pressure, is related to the relative humidity of the surrounding air by the Kelvin equation:

$$p_{\text{suc}} = -\rho_w R_w \Theta \ln \phi \quad (7.22)$$

where  $\rho_w$  is the density of water ( $\text{kg}\cdot\text{m}^3$ ),  $R_w$  is gas constant for water ( $= 461 \text{ J}\cdot\text{kg}^{-1}\cdot\text{W}^{-1}$ ),  $\Theta$  is the temperature of the water (K) and  $\phi$  is the relative humidity (%).

# 7.7 Interstitial Condensation

Expanded from the old 7.6.5, with new sections

- 7.7.1 Risks of interstitial Condensation,
- 7.7.2 Diffusion (Glaser) model,
- 7.7.3 Drying of components with entrapped moisture
- 7.7.4 Full models, which discusses the models standardised in BS EN 15026, i.e. WUFI.

# 7.8 Inside and outside design conditions

Generally unchanged from the old 7.7, but with the addition of climate classes defined in BS EN ISO 13788 and BS EN 15026.

New sections 7.8.5.2 and 7.8.5.3 on boundary conditions for ground floors.

## 7.8.5.2 Ground bearing floors

Condensation within ground floors is relatively unusual, however there is a risk in some constructions types and cases of floors collapsing due to condensation have occurred.

Heat flow into the ground is a complex process, which depends on a large number of factors; these are discussed fully in BS EN ISO 13370 (2007).

The risk of interstitial condensation in a ground bearing floor may be calculated by taking the external conditions as a variable monthly temperature and a constant 100% relative humidity below a 2-metre layer of soil below the floor structure. It is important to note that the external air temperature and humidity should still be used to calculate the internal vapour pressure as described in section 7.8.1.

# 7.9 Condensation calculations

Generally unchanged from old 7.8, with addition of new section 7.9.2.5 Condensation in the insulation of cold pipes, where calculations use cylindrical coordinates

## 7.9.2.5 Condensation in the insulation of cold pipes

The risk of interstitial condensation occurring in insulation surrounding pipes carrying cold liquid or gas can be calculated using the method specified in 7.9.2.3 by replacing the vapour resistance of each layer with a resistance modified to allow for the cylindrical geometry:

$$z'_j = \frac{\ln\left(\frac{d_j}{d_{j-1}}\right)}{2\pi\delta_{p,j}} \quad (7.41)$$

# Current Developments

DCLG have just let an 18 month contract to PRP Environmental for a complete review of knowledge and research in this area; once that is complete towards the end of 2016 they will start the process of revising Approved Document C

Historic Scotland Technical Paper 15, by Joseph Little, which should be published shortly, is a major analysis of the processes concerned with moisture risks in insulated solid masonry walls



# Current Developments

Analysis based on BS EN 15026 (i.e WUFI) is being increasingly used, in place of the traditional 'Glaser' method in BS EN ISO 13788, without there being clear guidance as to which method is appropriate for any given system.

It is apparent that the distinction that has been made between problems of 'interstitial condensation' and problems from other moisture sources, especially driving rain, is unhelpful

BS 5250, will be completely revised in 2017





**Marialena Nikolopolou**

**Professor of Sustainable Architecture, Director of CASE  
Kent School of Architecture**

## Chapter 8 – Health Issues



# Thermal discomfort and health implications

- Regulatory background
- Heat stress/discomfort and heat exhaustion
- Acclimatization and difference between heat and cold
- Cold discomfort
- Implications on the human body and productivity
- Thermal environment and adaptive comfort
- Links with A1
- Burns

# Humidity

- Thermal comfort
- Problems with high humidity:
  - of increasing concern in the UK
  - From 4 paragraphs to 1.5 page
  - House Dust Mites
  - Recommendations
- Problems with low humidity

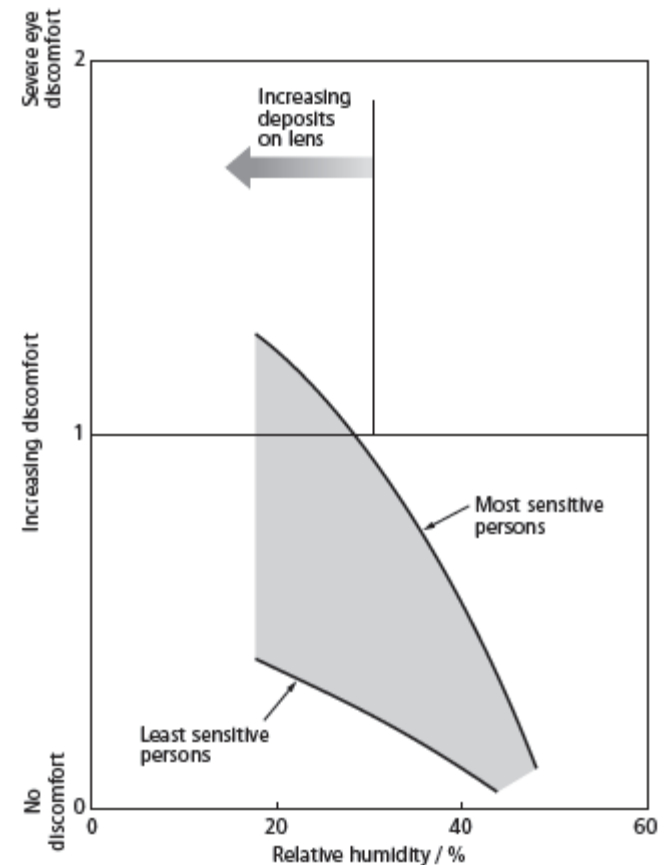

**Figure 8.6** Influence of relative humidity on eye discomfort with contact lens (source: Nilsson and Andersson (1986); © 1986 Institution Acta Ophthalmologica Scandinavica; reproduced by permission of John Wiley and Sons)

# House dust mites

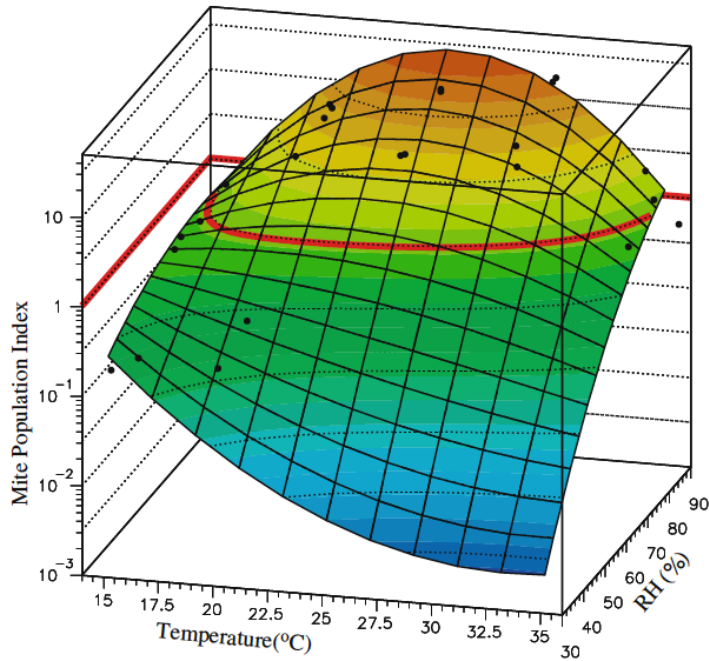

The mite population index model: graphic representation of lab results for population growth at varying combinations of temperature and RH

(Source: Crowther *et al*, 2006)

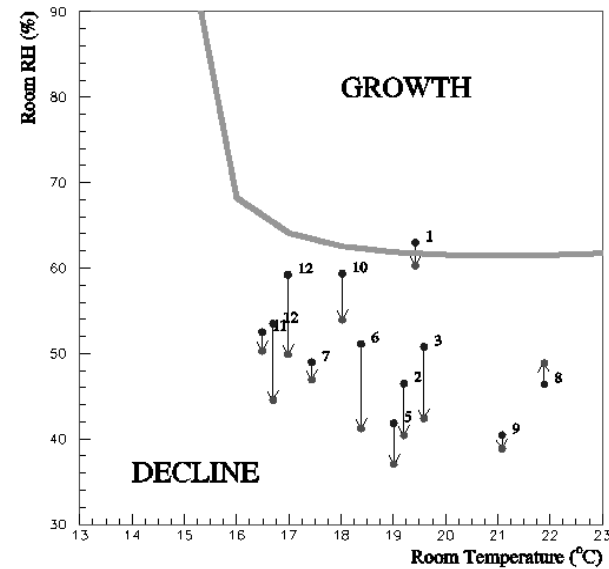

Predicted bedroom mite growth risk, using adjusted hygrothermal conditions: pre- versus post-intervention

The interventions included combinations of occupants' behaviours on moisture production, heating and ventilation habits.

(Source: Ucci *et al*, 2007)



# Air quality and ventilation

- Regulatory guidelines (Links with A1)
- Indoor pollutants and their sources
- Health effects of pollutants
  - Incl. SARS & microbiological contamination of the ventilation paths
- Sensory effects of pollutants
- Methods of controlling pollutants (Links with A1)
- Outdoor air
- Sick building syndrome
- Air quality and productivity
- Advice on smoking – NOT provided (smoking ban)



# Visual environment

- Legislation
- Light as radiation
- Light operating through the visual system
- Light operating through the circadian system
- Light as a purifier
  - increased from 3 paragraphs to 2 pages
  - Building air applications
  - Lamps, safety and maintenance
  - Further guidance

# Ultra-Violet Germicidal Irradiation (UVGI)

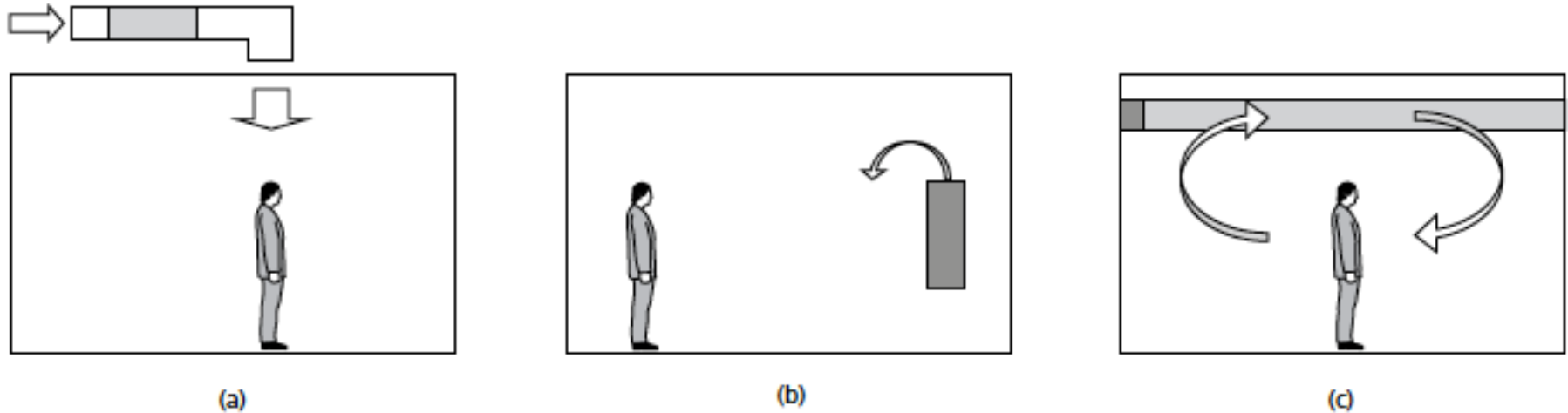

Typical applications of UVGI to room air:

(a) In-duct application—treatment of supply air

(b) Local in-room devices—recirculation and treatment of the air within a room

(c) Upper-room device—treatment of room air via a UV zone above occupants' heads

# Water quality

- Regulatory background
- Drinking water
- Hot water
- Scalds
- Legionnaires' disease
- Cleaning and disinfection of water systems
- Dispersive systems
- Ozone
- UV-C treatment

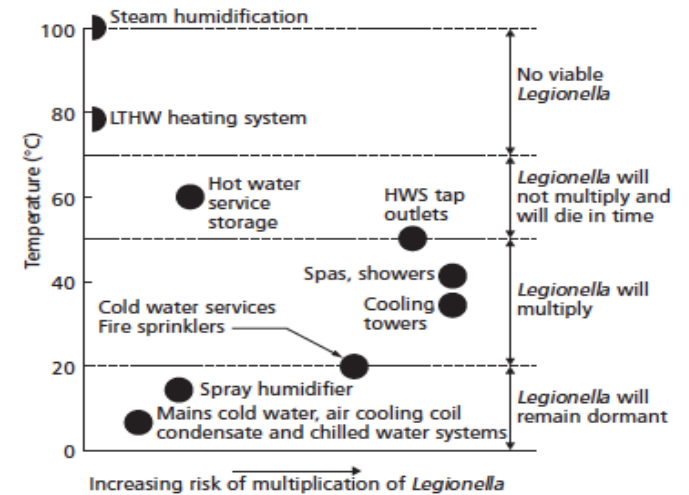

System design/operating temperatures and multiplication of *Legionella*  
(Source: CIBSE, TM13, 2013)



# Electromagnetic effects & Noise and vibration

## Electromagnetic effects

- Links with A1
- Air ionisation
- Static electricity

## Noise and vibration

- Links with A1
- Noise and health
- Static electricity
- Hearing damage
- Vibration
- Building services vibration
- Acoustic requirements in healthcare facilities

# Communities and health

## Health impact assessment (HIA)

HIA is 'a means of assessing the health impacts of policies, plans and projects in diverse economic sectors using quantitative, qualitative and participatory techniques'

### (WHO)

An independent tool for promoting public health in projects and policies.

# Q and A session

**Thanks to everyone for attending**

**Drinks and canapés**

**Access to the Guide to buy or download (free to members) is via:**

**[www.cibse.org/GuideA](http://www.cibse.org/GuideA)**

**These slides will be made available after the event on the CIBSE: [www.cibse.org/GuideA](http://www.cibse.org/GuideA)**